

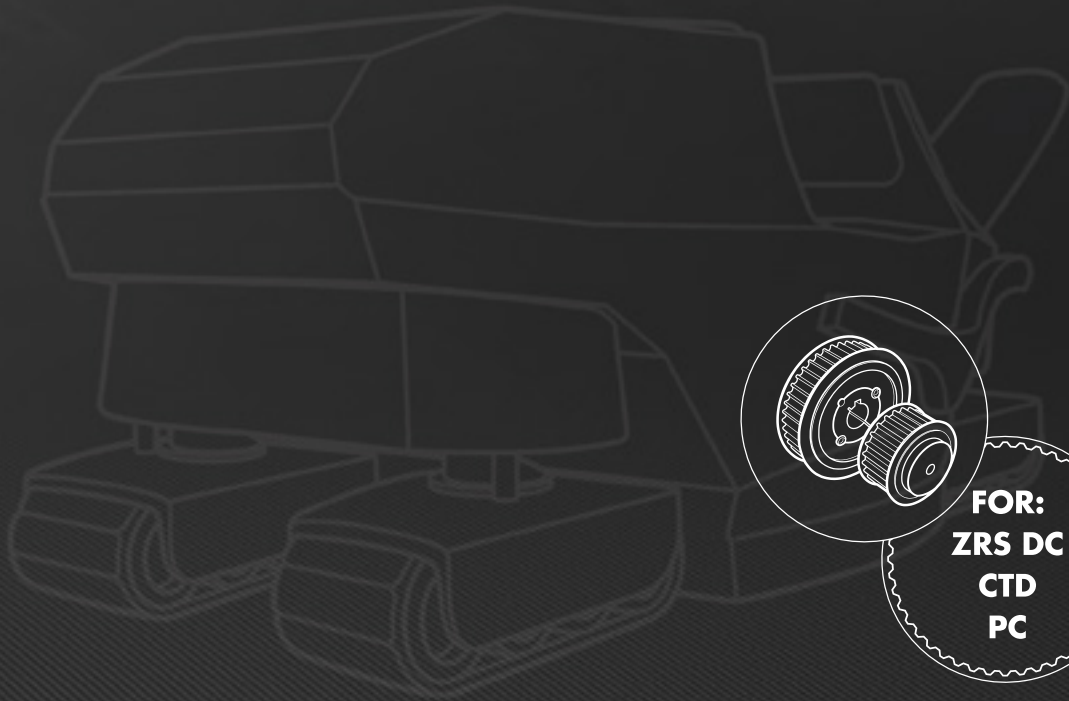

**OPTIBELT**  
**TECHNICAL MANUAL**  
**optibelt DELTA CHAIN Carbon**

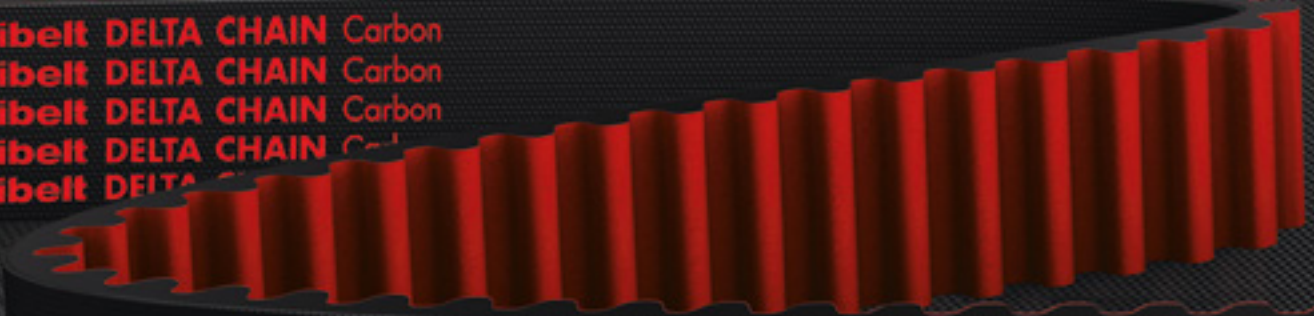

optibelt DELTA CHAIN Carbon  
optibelt DELTA CHAIN Carbon  
optibelt DELTA CHAIN Carbon  
optibelt DELTA CHAIN Carbon  
optibelt DELTA CHAIN Carbon





# TECHNICAL MANUAL

## optibelt **DELTA CHAIN Carbon**

The **optibelt DELTA CHAIN Carbon** sets new standards in the market for high performance timing belts. Endless **optibelt DELTA CHAIN Carbon** high performance timing belts together with the associated ZRS DC timing belt pulleys enable slip-free synchronous power transmission of up to several hundred kilowatts. Up to 100% higher power transmission is possible compared to high performance rubber timing belts such as **optibelt OMEGA HP**. The particular focus here is on drives with very high torques. In general, the overall width can be considerably reduced for power drives with small and medium centre distances.

The innovative combination of materials comprising an extremely resistant polyurethane compound, an abrasion-resistant and specially treated polyamide fabric, as well as a carbon fibre cord, provides the **optibelt DELTA CHAIN Carbon** with unmatched strength and resistance to a wide range of chemicals, oils and fluids.

This means that the **optibelt DELTA CHAIN Carbon** is suitable for a wide variety of applications, including uses which were previously reserved for roller chains, for example.

All relevant information as well as the methods to calculate drives with **optibelt DELTA CHAIN Carbon** high performance timing belts are included in this manual. They are supplemented by the Optibelt product ranges and price lists for belts and pulleys, technical data sheets, the optibelt CAP software for drive design, CAD drawings of optibelt ZRS DC toothed pulleys and additional Optibelt documentation, which can be found in their current version on the Optibelt website.

If you have any further questions, please take advantage of the free service provided by our application engineers.

**OPTIBELT EUROPE**

**OPTIBELT AFRICA**

**OPTIBELT AMERICA**

**Optibelt's partners can  
be found in most countries  
throughout the world**



**Optibelt GmbH**  
[www.optibelt.com](http://www.optibelt.com)



**Optibelt Nederland B.V.**  
[www.optibelt.nl](http://www.optibelt.nl)



**Optibelt GmbH**  
[www.optibelt.be](http://www.optibelt.be)



**Optibelt Österreich GmbH**  
[www.optibelt.at](http://www.optibelt.at)



**Optibelt Polska Sp. z o.o.**  
[www.optibelt.pl](http://www.optibelt.pl)



**Optibelt Hungary Kft.**  
[www.optibelt.hu](http://www.optibelt.hu)



**Optibelt (Canada) Inc.**  
[www.optibelt.ca](http://www.optibelt.ca)



**Optibelt de México**  
[www.optibelt.mx](http://www.optibelt.mx)



**Optibelt do Brasil Ltda.**  
[www.optibelt-br.com](http://www.optibelt-br.com)



**Optibelt Indonesia**  
[www.optibelt.co.id](http://www.optibelt.co.id)



**Optibelt Asia Pacific  
Pte. Ltd.**  
[www.optibelt.sg](http://www.optibelt.sg)



**Optibelt  
Power Transmission  
(Shanghai) Co., Ltd.**  
[www.optibelt.cn](http://www.optibelt.cn)

## OPTIBELT ASIA

## OPTIBELT AUSTRALIA



**Optibelt AG**  
[www.optibelt.ch](http://www.optibelt.ch)



**Optibelt (UK) Ltd.**  
[www.optibelt.co.uk](http://www.optibelt.co.uk)



**Optibelt France SAS**  
[www.optibelt.fr](http://www.optibelt.fr)



**Optibelt AG**  
[www.optibelt.it](http://www.optibelt.it)



**Optibelt España, S.A.**  
[www.optibelt.es](http://www.optibelt.es)



**Optibelt Güç Aktarma  
Ekipmanları San.  
Ve Tic Ltd. Sti.**  
[www.optibelt.com.tr](http://www.optibelt.com.tr)



**OOO „Optibelt  
Power Transmission“**  
[www.optibelt.ru](http://www.optibelt.ru)



**Optibelt Finland Oy**  
[www.optibelt.fi](http://www.optibelt.fi)



**Optibelt Skandinaviska AB**  
[www.optibelt.se](http://www.optibelt.se)



**Optibelt Corporation**  
[www.optibelt.us](http://www.optibelt.us)



**Optibelt Colombia S. A. S.**  
[www.optibelt.com](http://www.optibelt.com)



**Optibelt  
Power Transmission  
India Pvt. Ltd.**  
[www.optibelt.in](http://www.optibelt.in)



**Optibelt  
Australia Pty Ltd.**  
[www.optibelt.com.au](http://www.optibelt.com.au)



**Optibelt TRANZ Corp.**  
[www.optibelt.co.nz](http://www.optibelt.co.nz)



**Optibelt Philippines**  
[www.optibelt.ph](http://www.optibelt.ph)



**Optibelt Thailand**  
[www.optibelt.co.th](http://www.optibelt.co.th)



**Optibelt Vietnam**  
[www.optibelt.vn](http://www.optibelt.vn)



# TABLE OF CONTENTS



## 1 PRODUCT DESCRIPTION

## 2 TIMING BELT PRODUCT RANGE

## 3 DRIVE DESIGN

Introduction .....	1
Sales Organisation of the Arntz Optibelt Group .....	2 - 3
1.1 Structure .....	6
1.2 Features .....	7
1.3 Dimensions and Tolerances .....	8 - 9
2.1 The optibelt DELTA CHAIN Carbon 8MDC .....	10
2.2 The optibelt DELTA CHAIN Carbon 14MDC .....	11
3.1 Formula Symbols .....	12
3.2 Pre-Selection of the Profiles .....	13
3.3 Drive Service Factors .....	14
3.4 Additional Factors and Minimum Allowances .....	15
3.5 Formulae and Calculation Example .....	16 - 17
3.6 Belt Tension Adjustment by Frequency Measurement .....	18



# TABLE OF CONTENTS



## 4 POWER RATINGS

4.1 The optibelt DELTA CHAIN Carbon 8MDC .....	19
4.2 The optibelt DELTA CHAIN Carbon 14MDC .....	20

## 5 DESIGN HINTS

5.1 Timing Belt Pulleys/Tension Idlers .....	21
5.2 Installation and Maintenance .....	22
5.3 Problems – Causes – Remedies .....	23

## 6 TOOTHED PULLEYS

6.1 Minimum Pulley Diameter and Designs .....	24
6.2 Dimensions and Tolerances .....	25 - 26
6.3 Taper Bush Range .....	27
6.4 Toothed Pulley Range .....	28 - 33

## 7 GENERAL INFORMATION

7.1 Overview of Standards .....	34
7.2 Data Sheet for Calculation .....	35



# 1 PRODUCT DESCRIPTION

## 1.1 STRUCTURE

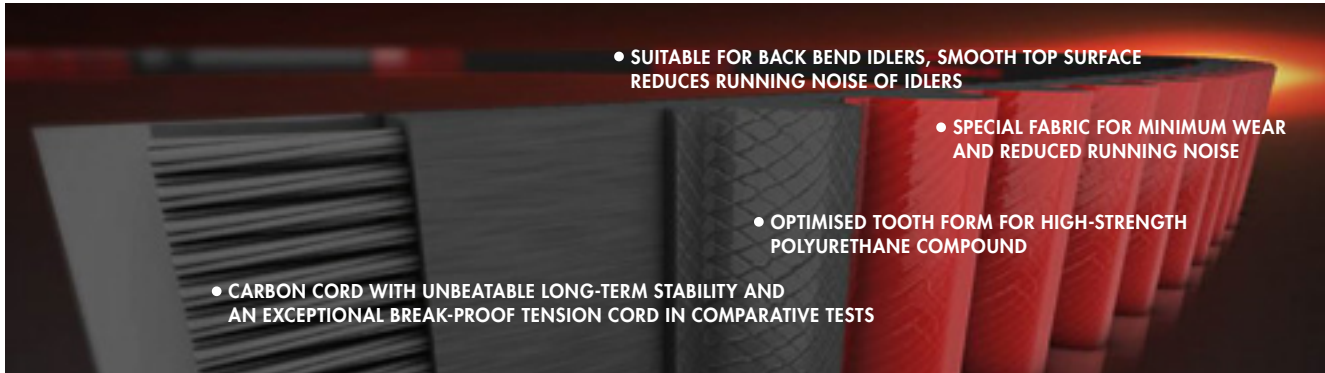

### TEETH

The teeth and also the top layer are made of high-strength cast polyurethane or thermoset and an extremely wear-resistant fabric. Both features give the teeth outstanding shear strength.

### TOOTH-SIDE FABRIC

The shear strength of the teeth is enhanced by a strong, coated and well-bonded fabric. Friction between the belt and the pulley is also reduced. This reduces the degree to which the friction partners heat up and minimises the running noise.

### TOOTH PROFILE

The curved tooth profile of the **optibelt DELTA CHAIN Carbon** timing belt ensures that it perfectly meshes and engages with the precisely fitting grooves on the matching **optibelt ZRS DC** pulleys. This tooth profile is not compatible with Omega or HTD, RPP and STD profiles. Consequently, the use of **optibelt DELTA CHAIN Carbon** timing belts is only recommended for **optibelt ZRS DC** pulleys or CTD or PC pulleys with the same profile. These and all other significant curved profiles, particularly including those of the pulleys referred to above, are standardised in ISO 13050.

### TENSION CORD

In contrast to rubber and polyurethane timing belts e.g. the **optibelt ALPHA** product groups, a tension cord made of carbon fibres is used. This stands out particularly with its ability to transmit extremely high forces. Carbon cord achieves unmatched length stability and outstanding breakage resistance in comparison to all other tension cords such as those made of glass, steel or aramid. **optibelt DELTA CHAIN Carbon** timing belts must not be bent otherwise the carbon tension cord will be damaged.

### TOP SURFACE

The smooth top surface of the belt consists of an abrasion-resistant, thin, and thus bendable polyurethane compound. Due to the smooth top surface as opposed to a grooved structure, a back bend idler can be used without any significant increase in the noise level.

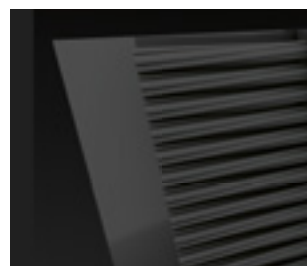
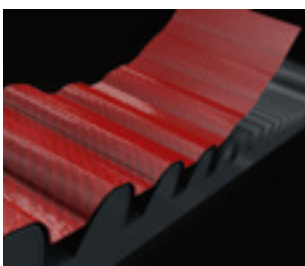



# 1 PRODUCT DESCRIPTION

## 1.2 FEATURES



### POWER TRANSMISSION

Up to 100% higher power transmission is possible compared to high performance rubber timing belts such as the **optibelt OMEGA HP**. The particular focus here is on drives with very high torques. In general, the overall width can be considerably reduced for power drives with small and medium centre distances.

### RESISTANCE TO CHEMICALS

Due to the materials used, especially the elastomer polyurethane used in this case, the **optibelt DELTA CHAIN Carbon** exhibits good to very good resistance to oils, greases and a large number of aggressive chemicals when compared to rubber. Verification of the selected drive in tests is generally recommended. Simple swelling tests should be performed in advance.

### TEMPERATURE RESISTANCE

The timing belt withstands temperatures of approx.  $-30^{\circ}\text{C}$  to  $+80^{\circ}\text{C}$ .  
Temperatures exceeding this level may result in premature failure of the belt.

### EFFICIENCY

Timing belt drives operate synchronously with positive engagement power transmission, i.e. without speed loss, in contrast to drives with frictional power transmission. Despite the high-strength polyurethane, the belt is still flexible in the bending direction, and the specially developed tooth fabric provides almost frictionless engagement with the teeth, resulting in up to 98% efficiency.

### NOISE EMISSIONS

The optimised tooth shape and the coated, tooth-facing fabric minimise friction and the noise that occurs when the tooth engages with the pulley. Moreover, by reducing the belt width by up to 50% compared to high performance rubber timing belts, the noise component caused by air displacement is also considerably reduced. This means overall that the relatively hard **optibelt DELTA CHAIN Carbon** is able to match, or even improve on, the noise level of rubber timing belts, especially compared to much wider standard rubber or polyurethane timing belts.

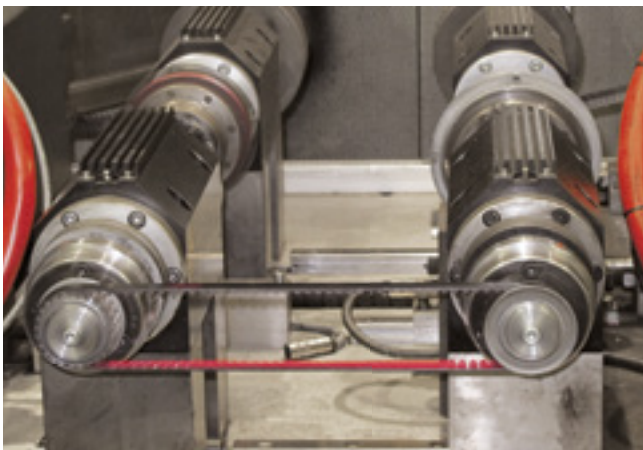

Figure 1.2.1: Test bench

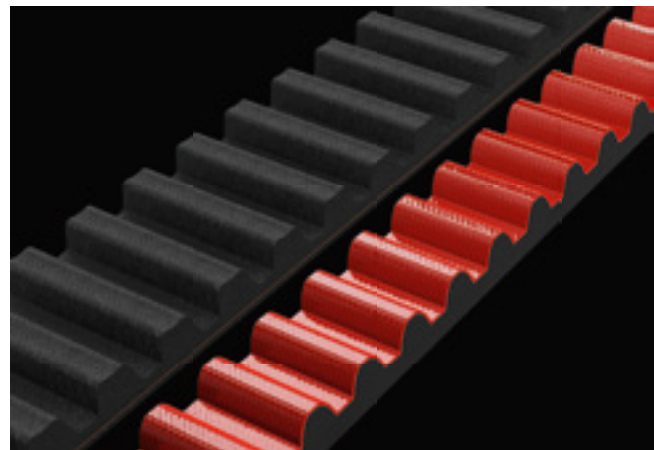

Figure 1.2.2: Reduced width

# 1 PRODUCT DESCRIPTION

## 1.3 DIMENSIONS AND TOLERANCES



Table 1.3.1: Nominal dimensions and weights per metre

Profile	Tooth pitch	Overall height	Tooth height	Metre weight per mm width [kg/(m*mm)]
	t [mm]	h [mm]	h <sub>t</sub> [mm]	
<b>8MDC</b>	8.0	5.9	3.4	0.0048
<b>14MDC</b>	14.0	10.2	6.0	0.0079

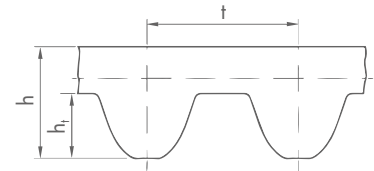

Figure 1.3.1: Profile DC

### LENGTH TOLERANCES

The length tolerances indicated in Table 1.3.2 refer to the centre distance.  
The measuring arrangement is shown in Figure 1.3.2.

Table 1.3.2: Length Tolerances

Timing belt length L <sub>w</sub> [mm]	Length tolerance a <sub>L Tol</sub> [mm]
< 760	± 0.30
> 786 < 1016	± 0.33
> 1022 < 1272	± 0.36
> 1274 < 1520	± 0.41
> 1526 < 1778	± 0.43
> 1784 < 2032	± 0.46
> 2040 < 2282	± 0.49
> 2288 < 2536	± 0.52
> 2544 < 2792	± 0.54
> 2800 < 3048	± 0.56
> 3052 < 3304	± 0.58
> 3312 < 3566*	± 0.60

\*For longer lengths, 0.03 mm have to be added for each increment of 250 mm.

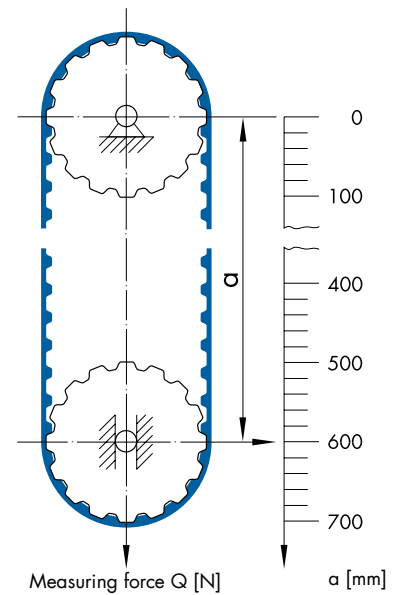

Figure 1.3.2: Arrangement to measure the belt length

Table 1.3.3: Measuring forces to determine the belt length

Profile	Width [mm]								
	12	20	21	36	37	62	68	90	125
	Measuring force [N]								
<b>8MDC</b>	267		467	756		1223			
<b>14MDC</b>		1179			2046		3447	4315	5627

# 1 PRODUCT DESCRIPTION

## 1.3 DIMENSIONS AND TOLERANCES

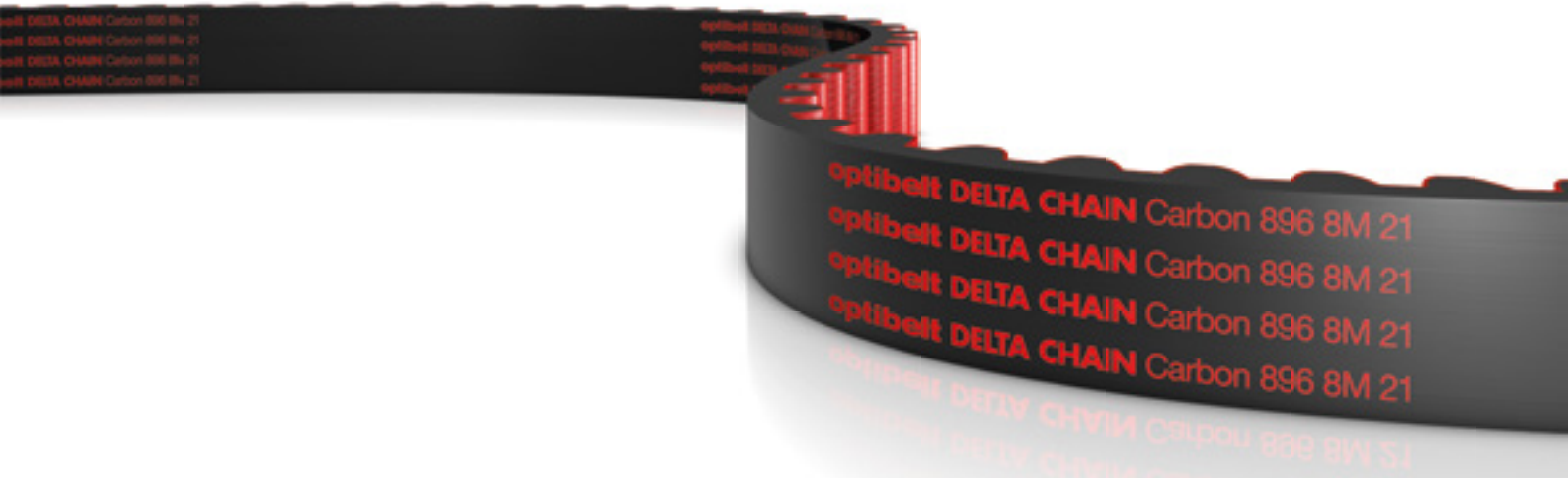

Table 1.3.4: Width tolerance

Profile	Width [mm]	Permissible tolerance of belt width [mm]		
		Pitch length $L_w$ $\leq 840$ mm	Pitch length $L_w$ $> 840$ mm $\leq 1680$ mm	Pitch length $L_w$ $> 1680$ mm
<b>8MDC</b>	< 12	$\pm 0.4$	+0.4/-0.8	$\pm 0.8$
	$\geq 12$ < 21	$\pm 0.8$	+0.8/-1.2	+0.8/-1.2
	$\geq 21$ < 36	$\pm 0.8$	+0.8/-1.2	+0.8/-1.2
	$\geq 36$ < 62	$\pm 0.8$	+0.8/-1.2	+0.8/-1.2
	$\geq 62$	$\pm 1.2$	+1.2/-1.6	$\pm 1.6$
<b>14MDC</b>	< 20	$\pm 0.8$	$\pm 0.8$	+0.8/-1.2
	$\geq 20$ < 37	$\pm 0.8$	+0.8/-1.2	+0.8/-1.2
	$\geq 37$ < 68	$\pm 0.8$	+0.8/-1.2	+0.8/-1.2
	$\geq 68$ < 90	+1.2/-1.6	$\pm 1.6$	+1.6/-2.0
	$\geq 90$ < 125	$\pm 1.6$	+1.6/-2.0	$\pm 2.0$
	$\geq 125$	$\pm 2.4$	+2.4/-2.8	+2.4/-3.2

### STANDARDIZATION

optibelt DELTA CHAIN Carbon timing belts and optibelt ZRS DC pulleys are standardized in ISO 13050.



# 2 TIMING BELT PRODUCT RANGE

## 2.1 optibelt DELTA CHAIN Carbon 8MDC

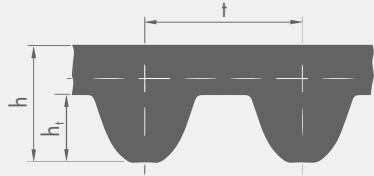

Profile	8MDC
t [mm]	8.0
h [mm]	5.9
ht [mm]	3.4

### optibelt DELTA CHAIN Carbon 8MDC

Profile, length	Pitch length $L_w$ [mm]	Number of teeth	Profile, length	Pitch length $L_w$ [mm]	Number of teeth
8MDC 640	640.00	80			
8MDC 720	720.00	90			
8MDC 800	800.00	100			
8MDC 896	896.00	112			
8MDC 960	960.00	120			
8MDC 1000	1000.00	125			
8MDC 1040	1040.00	130			
8MDC 1120	1120.00	140			
8MDC 1200	1200.00	150			
8MDC 1224	1224.00	153			
8MDC 1280	1280.00	160			
8MDC 1440	1440.00	180			
8MDC 1600	1600.00	200			
8MDC 1760	1760.00	220			
8MDC 1792	1792.00	224			

Please also refer to the current product range or inquire about other dimensions.

**Standard widths:** 12 mm, 21 mm, 36 mm, 62 mm  
Intermediate widths on request

#### Example order:

optibelt DELTA CHAIN Carbon 1120 8MDC 21

1120 = pitch length  $L_w$  [mm]

8MDC = profile

21 = width [mm]

# 2 TIMING BELT PRODUCT RANGE

## 2.2 optibelt DELTA CHAIN Carbon 14MDC

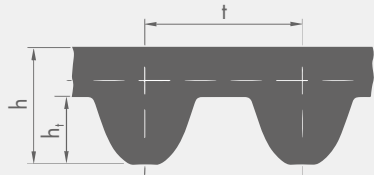

Profile	14MDC
t [mm]	14.0
h [mm]	10.2
ht [mm]	6.0

### optibelt DELTA CHAIN Carbon 14MDC

Profile, length	Pitch length $L_w$ [mm]	Number of teeth	Profile, length	Pitch length $L_w$ [mm]	Number of teeth
<p><b>PRODUCT RANGE OF</b>  <b>optibelt DELTA CHAIN Carbon</b>  <b>HIGH PERFORMANCE TIMING BELTS</b>  <b>PROFILE 14MDC</b></p> <p><b>UNDER DEVELOPMENT</b></p> <p>Please also refer to the current product range                      or inquire about other dimensions.</p> <p><b>Standard widths:</b> 20 mm, 37 mm, 68 mm, 90 mm, 125 mm                      Intermediate widths on request</p>					

**Example order:**

optibelt DELTA CHAIN Carbon 1400 14MDC 37

1400 = pitch length  $L_w$  [mm]

14MDC = profile

37 = width [mm]



# 3 DRIVE DESIGN

## 3.1 FORMULA SYMBOLS



Table 3.1.1: Formula symbols

Formula symbols	Explanation	Unit	Formula symbols	Explanation	Unit
$a$	Drive centre distance	[mm]	$n_2$	Speed of the driven timing belt pulley	[min <sup>-1</sup> ]
$a_{nom}$	Drive centre distance, calculated with a standard belt length	[mm]	$P$	Power to be transmitted from timing belt drive	[kW]
$c_0$	Base drive service factor		$P_B$	Design power	[kW]
$c_1$	Tooth meshing factor		$P_N$	Rated power	[kW]
$c_2$	Total drive service factor		$P_{\ddot{U}}$	Power transmitted from a standard belt width [ $P_N \cdot c_1 \cdot c_7$ ]	[kW]
$c_3$	Speed ratio correction factor		$F_a$	Minimum static shaft loading	[N]
$c_6$	Fatigue allowance		$F_{n\text{ perm}}$	Maximum permitted circumferential force	[N]
$c_7$	Length factor		$F_{n3}$	Circumferential force to be effectively transmitted	[N]
$d_a$	Outside diameter of timing belt pulley	[mm]	$F_n$	Circumferential force to be effectively transmitted incl. actual centrifugal force	[N]
$d_w$	Pitch diameter of timing belt pulley	[mm]	$t$	Tooth pitch	[mm]
$d_{wg}$	Pitch diameter of large timing belt pulley	[mm]	$v$	Belt speed (velocity)	[m/s]
$d_{wk}$	Pitch diameter of small timing belt pulley	[mm]	$x$	Minimum allowance of the drive centre distance $a_{nom}$ for installation of the timing belt	[mm]
$d_{w1}$	Pitch diameter of driving pulley	[mm]	$z_e$	Number of meshed teeth of the small driving pulley	
$d_{w2}$	Pitch diameter of driven pulley	[mm]	$z_g$	Number of teeth of the large driving pulley	
$E_a$	Belt deflection for a given span length	[mm]	$z_k$	Number of teeth of the small driving pulley	
$F$	Test force	[N]	$z_R$	Number of teeth of the timing belt	
$f$	Frequency	[Hz]	$z_1$	Number of teeth of the driving pulley	
$i$	Speed ratio		$z_2$	Number of teeth of the driven pulley	
$L$	Span length	[mm]			
$L_{wSt}$	Standard pitch length of the timing belt	[mm]			
$L_{wth}$	Calculated pitch length of the timing belt	[mm]			
$n_1$	Speed of the driving pulley	[min <sup>-1</sup> ]			

Figure 3.1.1: Example of a drive geometry: Belts and pulleys

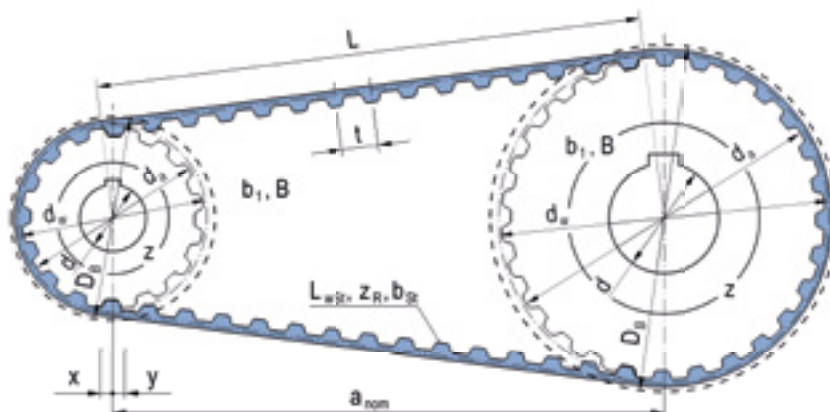

# 3 DRIVE DESIGN

## 3.2 PRE-SELECTION OF THE PROFILES



Graph 3.2.1: Pre-selection of profiles 8MDC and 14MDC

See also optibelt CAP drive calculation, software at [www.optibelt.com](http://www.optibelt.com)

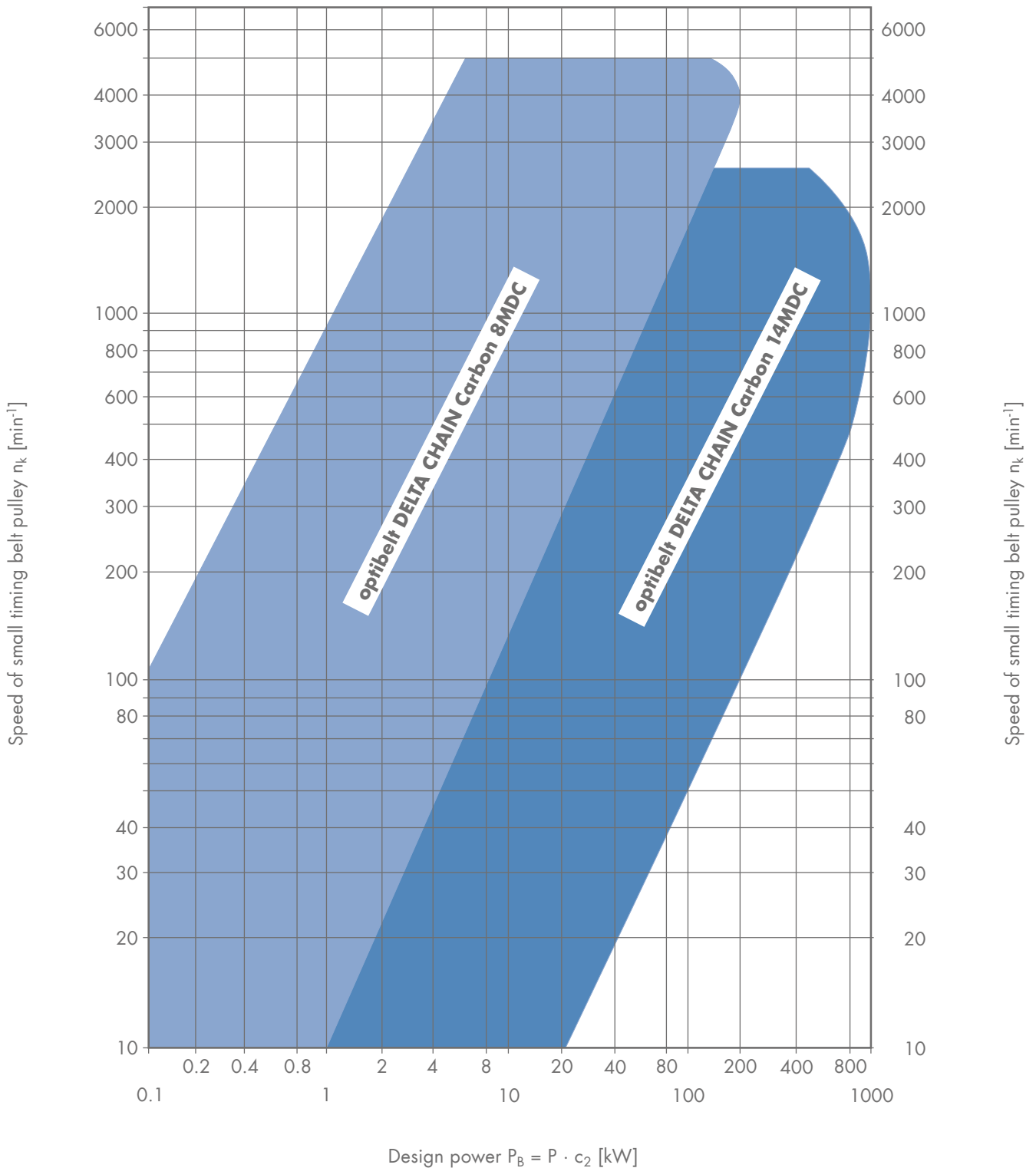

# 3 DRIVE DESIGN

## 3.3 DRIVE SERVICE FACTORS



### TOTAL DRIVE SERVICE FACTOR $c_2$

The total drive service factor  $c_2$  is composed of the base drive service factor  $c_0$  and two further allowances  $c_3$  and  $c_6$ .

$$c_2 = c_0 + c_3 + c_6 \quad [-]$$

$$c_2 \geq \frac{M_A}{M_N}, \quad c_2 \geq \frac{M_{Br}}{M_N} \quad [-] \quad \text{at drive} \quad \text{with } M_A \text{ [Nm], } M_N \text{ [Nm] and } M_{Br} \text{ [Nm]}$$

$$c_2 \geq \frac{M_{Br}}{M_N \cdot i} \quad [-] \quad \text{at driven side} \quad \text{with } M_N \text{ [Nm], } M_{Br} \text{ [Nm] and } i \text{ [-]}$$

The total drive service factor  $c_2$  should also consider a high starting load  $M_A$  and a high braking load  $M_{Br}$  at the drive or a high braking load at the driven side in proportion to the rated load  $M_N$  of the driving machine.

With frequent switching operations and high starting or braking loads, which thus become the main load, while the power transmission itself recedes into the background, an additional safety allowance must be added to the maximum determined quotient.

**Table 3.3.1: Base drive service factor  $c_0$**

<div style="text-align: center; font-size: 2em; font-weight: bold;">c<sub>0</sub></div> <b>Type of base load and examples of a driven machine</b>	<b>Load type and examples of driving machines</b>			
	<b>Uniform run</b> Electric motor Fast-moving turbine Piston machine with high number of cylinders		<b>Irregular operation</b> Hydraulic motor Slow-moving turbine Piston machine with low number of cylinders	
	Base drive service factor $c_0$ for daily operating time			
	up to 16 h	above 16 h	up to 16 h	above 16 h
<b>Light drives, joint-free and uniform running</b> Measuring instruments Film cameras Office equipment Belt conveyors (light goods)	1.3	1.4	1.4	1.5
<b>Medium drives, temporary operation with small to medium impact loading</b> Mixing machines Food processors Printing machines Textile machines Packaging machines Belt conveyors (heavy goods)	1.6	1.7	1.8	1.9
<b>Heavy drives, operation with medium to strong temporary impact load</b> Machine tools Wood processing machines Eccentric drives Conveying systems (heavy goods)	1.8	1.9	2.0	2.1
<b>Very heavy drives, operation with strong permanent impact load</b> Mills Calenders Extruders Piston pumps and compressors Lifting gear	2.0	2.1	2.2	2.3

# 3 DRIVE DESIGN

## 3.4 ADDITIONAL FACTORS AND MINIMUM ALLOWANCES



### BASE DRIVE SERVICE FACTOR $c_0$

The base drive service factor  $c_0$  takes into account the daily operating time and the type of driver and driven units.

As it is not possible to summarise any thinkable combination of driver, driven unit and operating conditions in one table, the base drive service factors are to be considered as guide values. The assignment of the driven unit depends on the type of load that is present in each case.

For slowly operating drives with a speed of  $\leq 100 \text{ min}^{-1}$ , a base drive service factor of at least 2 is recommended.

### SPEED RATIO CORRECTION FACTOR $c_3$

For the speed step-up ratios, the value that corresponds to the speed ratio is added to the base drive service factor  $c_0$ .

**Table 3.4.1: Speed ratio correction factor**

Speed ratio $i$	Speed ratio correction factor $c_3$
$\geq 0.80$	0.0
$< 0.80 \geq 0.57$	0.1
$< 0.57 \geq 0.40$	0.2
$< 0.40 \geq 0.28$	0.3
$< 0.28$	0.4

**Table 3.4.2: Fatigue allowance  $c_6$**

Drive conditions	Fatigue allowance $c_6$
Use of tension or idler pulleys	0.2
Operating time 16–24 h	0.2
Only rare or occasional operation	-0.2

**Table 3.4.3: Length factor  $c_7$**

Profile 8MDC		Profile 14MDC	
Pitch length [mm]	$c_7$	Pitch length [mm]	$c_7$
$\leq 600$	0.8	$\leq 1190$	0.80
$> 600 \leq 880$	0.9	$> 1190 \leq 1610$	0.90
$> 880 \leq 1200$	1.0	$> 1610 \leq 1890$	0.95
$> 1200 \leq 1760$	1.1	$> 1890 \leq 2450$	1.00
$> 1760 \leq 2240$	1.2	$> 2450 \leq 3150$	1.05
$> 2240 \leq 2840$	1.3	$> 3150 \leq 3500$	1.10
$> 2840 \leq 3600$	1.4	$> 3500$	1.20
$> 3600$	1.5		

**Table 3.4.4: Tooth meshing factor  $c_1$**

Number of meshed teeth	Tooth meshing factor $c_1$
$\geq 6$	1.0
5	0.8
4	0.6
3	0.4
2	0.2

### Minimum allowance $x$ for tensioning timing belts

$$x = 0.004 \cdot a_{\text{nom}}$$

**Table 3.4.5: Minimum allowance  $y$  for installation of timing belt pulleys without flange**

Drive centre distances [mm]	Minimum allowance $y$ [mm]
$\leq 1000$	1.8
$> 1000 \leq 1780$	2.8
$> 1780 \leq 2540$	3.3
$> 2540 \leq 3300$	4.1
$> 3300 \leq 4600$	5.3

**Table 3.4.6: Minimum allowance  $y$  for installation of timing belt pulleys with flanges**

Profile	Flange on one timing belt pulley [mm]	Flange on both timing belt pulleys [mm]
8MDC	22	33
14MDC	36	58

# 3 DRIVE DESIGN

## 3.5 FORMULAE AND CALCULATION EXAMPLE



### PRIME MOVER

Electric motor 50 Hz  
star-delta connection  
 $P = 11 \text{ kW}$   
 $n_1 = 1450 \text{ min}^{-1}$

### DRIVE CONDITIONS

Operational hours per day: 12 hours  
Number of starts: Twice per day  
Environmental influences: Ambient temperature,  
no influence of oil, water and dust  
Drive centre distance: 400 mm to 450 mm  
Maximum pulley diameter: 200 mm

### DRIVEN MACHINE

Paper machine  
 $n_2 = 920 \text{ min}^{-1} \pm 2\%$   
Type of load: Constant

### FORMULAS

#### TOTAL DRIVE SERVICE FACTOR

$c_2 = c_0 + c_3 + c_6$   
 $c_0$  from Table 3.3.1  
 $c_3$  from Table 3.4.1  
 $c_6$  from Table 3.4.2

### CALCULATION EXAMPLE

$c_2 = 1.6 + 0 + 0 = 1.6$   
 $c_0 = 1.6$   
 $c_3 = 0$   
 $c_6 = 0$

### DESIGN POWER

$$P_B = P \cdot c_2$$

$$P_B = 11 \cdot 1.6 = 17.6 \text{ kW}$$

### TIMING BELT PROFILE

from Graph 3.2.1

### optibelt DELTA CHAIN Carbon

Profile 8MDC

### RECALCULATION OF SPEED

$$i = \frac{n_1}{n_2} = \frac{z_2}{z_1} = \frac{d_{w2}}{d_{w1}}$$

$$i = \frac{1450}{920} = 1.576$$

### NUMBER OF TEETH ON THE TIMING BELT PULLEYS

$z_1, d_{w1}$  Standard timing belt pulleys, see 6.4

$$z_2 = z_1 \cdot i$$

$$z_1 = 36$$

$$d_{w1} = 91.67 \text{ mm}$$

$$z_2 = 36 \cdot 1.56 = 56.16$$

$$z_2 = 56$$

$$d_{w2} = 142.60 \text{ mm}$$

Please observe minimum diameter!

Minimum number of teeth, see Table 6.1.1

Requirement  $z \geq 22$  minimum number of teeth for profile 8MDC met

### RECALCULATION OF SPEED

$$i = \frac{z_2}{z_1}$$

$$i = \frac{56}{36} = 1.556$$

$$n_2 = \frac{n_1}{i}$$

$$n_2 = \frac{1450}{1.556} = 932 \text{ min}^{-1}$$

Required:

$920 \text{ min}^{-1} \pm 2\%$  met

### RECOMMENDED DRIVE CENTRE DISTANCE

Recommendation

$$a > 0.5 (d_{w1} + d_{w2}) + 15 \text{ mm}$$

$$a > 0.5 (91.67 + 142.60) + 15 \text{ mm} = 132.14 \text{ mm}$$

$$a < 2.0 (d_{w1} + d_{w2})$$

$$a < 2.0 (91.67 + 142.60) = 468.54 \text{ mm}$$

$a = 425 \text{ mm}$  selected provisionally

See also optibelt CAP drive calculation, software at [www.optibelt.com](http://www.optibelt.com)



# 3 DRIVE DESIGN

## 3.5 FORMULAE AND CALCULATION EXAMPLE



### FORMULAS

#### PITCH LENGTH

$$L_{wth} \approx 2a + \frac{\pi}{2} (d_{wg} + d_{wk}) + \frac{(d_{wg} - d_{wk})^2}{4a}$$

$L_{wSt}$  see timing belt range in Chapter 2

#### NOMINAL DRIVE CENTRE DISTANCE

$$a_{nom} = K + \sqrt{K^2 - \frac{(d_{wg} - d_{wk})^2}{8}}$$

$$K = \frac{L_{wSt}}{4} - \frac{\pi}{8} (d_{wg} + d_{wk})$$

### CALCULATION EXAMPLE

$$L_{wth} \approx 2 \cdot 425 + \frac{\pi}{2} (142.60 + 91.67) + \frac{(142.60 - 91.67)^2}{8}$$

$L_{wth} \approx$  **1219.33 mm** (selected from Subchapter 2.1)

$L_{wSt} =$  **1200 mm**

$$a_{nom} = 208 + \sqrt{208^2 - \frac{(142.60 - 91.67)^2}{8}}$$

$a_{nom} =$  **415.22 mm**

$$K = \frac{1200}{4} - \frac{\pi}{8} (142.60 + 91.67) = 208 \text{ mm}$$

#### MINIMUM ALLOWANCE FOR TENSIONING

$$x = 0.004 \cdot a_{nom}$$

$$x \geq \mathbf{1.66 \text{ mm}}$$

#### MINIMUM ALLOWANCE FOR INSTALLATION

$y =$  from Table 3.4.6

$y =$  **33 mm** Flange on both timing belt pulleys

#### NUMBER OF MESHED TEETH ON THE SMALL PULLEY

$$z_e = \frac{z_k}{6} \left( 3 - \frac{d_{wg} - d_{wk}}{a_{nom}} \right) \text{ Round down value}$$

$$z_e = \frac{36}{6} \left( 3 - \frac{142.60 - 91.67}{415} \right) = 17.26$$

$z_e =$  **17**

#### BELT LENGTH CORRECTION FACTOR

$c_7$  from Table 3.4.3

$$c_7 = \mathbf{1.0}$$

#### TOOTH MESHING FACTOR

$c_1$  from Table 3.4.4

$$c_1 = \mathbf{1.0}$$

#### BELT WIDTH OVER RATED POWER

Required:  $P_{\bar{U}} \geq P_B$

$P_{\bar{U}}$  = transferable rated power of a standard belt width

$$P_{\bar{U}} = P_N \cdot c_1 \cdot c_7$$

$P_N$  (profile, b) =  $P_N$  · width factor (see Chapter 4)

**21.60 kW > 17.6 kW**

**Requirement met**

$$P_{\bar{U}} = 21.60 \cdot 1.0 \cdot 1.0 = \mathbf{21.60 \text{ kW}}$$

$$P_N \text{ (8MDC, } b = 21 \text{ mm)} = 12.34 \cdot 1.75 = \mathbf{21.60 \text{ kW}}$$

Result:

**1 pc. optibelt DELTA CHAIN Carbon timing belt**

**1200 8MDC 21**

**1 pc. optibelt ZRS DC timing belt pulley**

**36 8MDC 21**

**1 pc. optibelt ZRS DC timing belt pulley**

**56 8MDC 21**

# 3 DRIVE DESIGN

## 3.6 BELT TENSION ADJUSTMENT BY FREQUENCY MEASUREMENT



### TENSION FOR optibelt DELTA CHAIN Carbon TIMING BELT

The correct level of belt tension is of crucial importance for trouble-free transmission of power, and for achieving an acceptable belt service life. Often, tension which is either too high or too low results in early timing belt failure. A belt which is over-tensioned sometimes causes bearing failure in the driver or driven unit.

Adjustment of the specified static span force, e.g. using the thumbprint method, is not a suitable means of tensioning drives correctly in order to fully exploit them economically. Instead of this, adjustment of the static span force through frequency measurement, e.g. using instruments from the **optibelt TT** series, is recommended. The default value for the frequency measurement can be determined using the following formulas.

#### FORMULA SYMBOLS

$\beta$	[°]	Arc of contact	$F_a$	[N]	Static drive centre force
$f$	[Hz]	Frequency	$F_u$	[N]	Circumferential force
$m_k$	[kg/m]	Weight per metre	$t$	[mm]	Pitch
$L$	[mm]	Span length	$F_T$	[N]	Static span force
$n_k$	[1/min]	Speed of small pulley	$v$	[m/s]	Circumferential speed
$P_N$	[kW]	Rated power	$z_k$		Number of teeth of small pulley

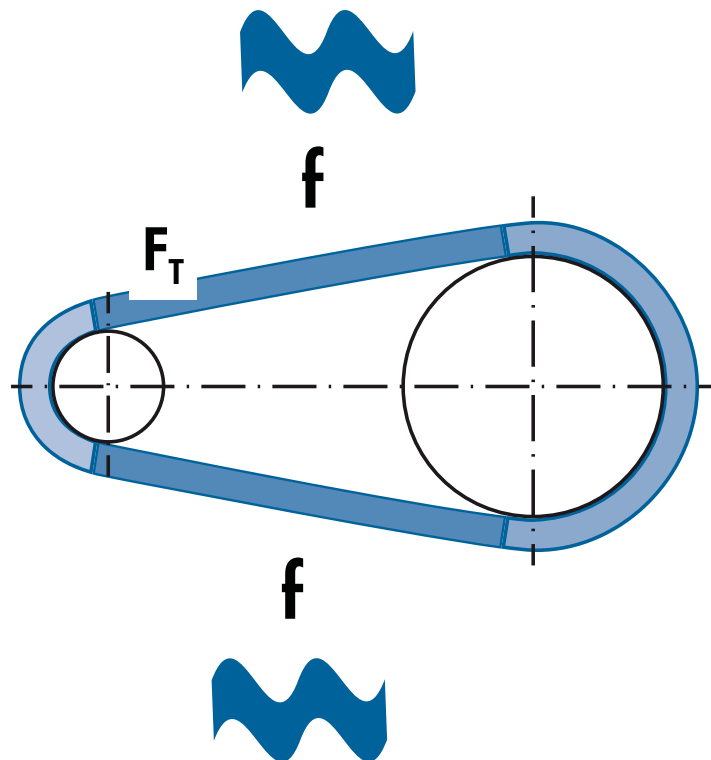

DRIVE CENTRE FORCE, STATIC	SPAN FORCE, STATIC	CIRCUMFERENTIAL FORCE	FREQUENCY
$F_a = 1.4 \cdot \frac{60 \cdot 10^6 \cdot P_N \cdot \sin \frac{\beta}{2}}{t \cdot z_k \cdot n_k}$	$F_T = 1.4 \cdot \frac{F_a}{2 \cdot \sin \frac{\beta}{2}}$	$F_u = \frac{P_N \cdot 1000}{v}$	$f = \sqrt{\frac{F_T \cdot 10^6}{4 \cdot m_k \cdot L^2}}$

# 4 POWER RATINGS

## 4.1 optibelt DELTA CHAIN Carbon profile 8MDC



Table 4.1.1: Rated power for profile 8MDC width 12 mm

Rated power $P_N$ [kW]																	
Speed of small timing belt pulley $n_k$ [min <sup>-1</sup> ]	Number of teeth on the small pulley $z_k$																
	22	25	28	30	32	34	36	38	40	45	48	50	56	60	64	75	80
	Pitch diameter of the small timing belt pulley $d_{wk}$ [mm]																
	56.02	63.66	71.30	76.39	81.49	86.58	91.67	96.77	101.86	114.59	122.23	127.32	142.60	152.79	162.97	190.99	203.72
10	0.07	0.08	0.10	0.11	0.12	0.13	0.14	0.15	0.16	0.19	0.21	0.22	0.25	0.27	0.29	0.34	0.37
20	0.13	0.15	0.18	0.20	0.22	0.24	0.26	0.28	0.30	0.34	0.38	0.40	0.46	0.50	0.54	0.64	0.69
40	0.25	0.29	0.34	0.38	0.41	0.44	0.48	0.51	0.55	0.63	0.70	0.74	0.84	0.92	1.00	1.22	1.31
60	0.37	0.43	0.50	0.55	0.60	0.65	0.70	0.74	0.79	0.91	1.01	1.07	1.20	1.32	1.44	1.76	1.89
100	0.59	0.70	0.81	0.88	0.96	1.03	1.11	1.19	1.27	1.46	1.60	1.69	1.94	2.12	2.30	2.81	3.01
200	1.08	1.31	1.55	1.70	1.86	2.02	2.17	2.32	2.48	2.86	3.09	3.25	3.69	4.00	4.30	5.11	5.49
300	1.52	1.87	2.20	2.44	2.66	2.88	3.10	3.33	3.55	4.11	4.43	4.66	5.31	5.74	6.18	7.36	7.89
400	1.95	2.39	2.84	3.14	3.43	3.72	4.01	4.30	4.60	5.32	5.74	6.03	6.88	7.45	8.01	9.55	10.24
500	2.36	2.91	3.45	3.83	4.18	4.53	4.90	5.26	5.61	6.49	7.02	7.38	8.42	9.11	9.80	11.68	12.53
600	2.77	3.42	4.07	4.50	4.92	5.35	5.76	6.19	6.61	7.65	8.28	8.70	9.92	10.75	11.56	13.79	14.79
700	3.17	3.92	4.66	5.15	5.64	6.14	6.63	7.11	7.59	8.80	9.52	9.99	11.42	12.36	13.30	15.86	17.02
800	3.55	4.40	5.25	5.80	6.36	6.91	7.47	8.02	8.56	9.92	10.74	11.27	12.89	13.95	15.01	17.91	19.21
900	3.94	4.88	5.82	6.44	7.06	7.68	8.30	8.91	9.52	11.04	11.94	12.54	14.34	15.52	16.70	19.93	21.38
1000	4.31	5.36	6.39	7.08	7.76	8.44	9.12	9.79	10.47	12.14	13.14	13.80	15.77	17.08	18.38	21.93	23.52
1200	5.05	6.29	7.52	8.33	9.13	9.94	10.75	11.54	12.34	14.31	15.49	16.28	18.60	20.15	21.68	25.86	27.74
1400	5.77	7.20	8.61	9.55	10.48	11.42	12.34	13.25	14.18	16.45	17.81	18.70	21.39	23.17	24.93	29.73	31.89
1600	6.48	8.10	9.70	10.76	11.81	12.86	13.90	14.95	15.98	18.55	20.08	21.10	24.13	26.13	28.12	33.53	35.96
1800	7.18	8.98	10.77	11.94	13.12	14.29	15.44	16.61	17.76	20.62	22.32	23.46	26.83	29.05	31.26	37.26	39.96
2000	7.86	9.85	11.81	13.11	14.41	15.69	16.98	18.24	19.51	22.67	24.54	25.78	29.49	31.93	34.36	40.93	43.88
2400	9.20	11.55	13.87	15.40	16.94	18.46	19.97	21.47	22.96	26.68	28.88	30.35	34.69	37.56	40.41	48.09	51.52
2800	10.51	13.21	15.88	17.65	19.40	21.15	22.89	24.62	26.33	30.59	33.12	34.79	39.77	43.03	46.27	55.00	58.87
3200	11.78	14.82	17.85	19.84	21.83	23.79	25.75	27.69	29.63	34.42	37.25	39.13	44.70	48.35	51.96	61.65	
3500	12.71	16.02	19.29	21.45	23.60	25.73	27.85	29.96	32.05	37.23	40.28	42.31	48.31	52.24	56.11		
4000	14.24	17.97	21.65	24.09	26.51	28.91	31.29	33.66	36.00	41.80	45.22	47.48	54.14	58.51			
4500	15.72	19.87	23.97	26.67	29.35	32.00	34.64	37.25	39.85	46.23	49.99	52.47					
5000	17.17	21.72	26.22	29.18	32.02	35.02	37.90	40.75	43.58	50.52	54.60	57.28					
5500	18.58	23.53	28.41	31.63	34.81	37.96	41.08	44.15	47.20	54.66							

Further power values for other belt widths can be derived from multiplication with the width correction factors.

Permitted rated circumferential force $F_{N \text{ perm}}$ with $n_k \leq 100 \text{ min}^{-1}$ and $z_k \geq 40$				
Width [mm]	12	21	36	62
$F_{N \text{ perm}}$ [N]	2200	4000	7000	12 200

Width correction factor				
Width [mm]	12	21	36	62
Factor	1.00	1.75	3.00	5.17

# 4 POWER RATINGS

## 4.2 optibelt **DELTA CHAIN** Carbon profile 14MDC



Table 4.2.1: Rated power for profile 14MDC width 20 mm

Rated power $P_N$ [kW]	
Speed of small timing belt pulley $n_k$ [min <sup>-1</sup> ]	Number of teeth on the small pulley $z_k$
	Pitch diameter of the small timing belt pulley $d_{wk}$ [mm]
<p><b>POWER VALUES</b>  <b>optibelt DELTA CHAIN Carbon</b>  <b>PROFILE 14MDC</b></p> <p><b>UNDER DEVELOPMENT</b></p> <p>Further power values for other belt widths can be derived from multiplication with the width correction factors.</p>	

Permitted rated circumferential force $F_{N \text{ perm}}$ with $n_k \leq 100 \text{ min}^{-1}$ and $z_k \geq 40$				
Width [mm]				
$F_{N \text{ perm}}$ [N]				

Width correction factor				
Width [mm]				
Factor				

# 5 DESIGN HINTS

## 5.1 TIMING BELT PULLEYS / TENSION IDLERS



### FLANGES

To guide Optibelt timing belts, timing belt pulleys should be equipped with flanges on one or both sides. For drive centre distances  $a > 8 d_w$ , the timing belt pulleys are to be equipped with flanges on both sides. We recommend the use of standard timing belt pulleys. If this is not possible for design reasons, corresponding special timing belt pulley designs can be used.



Small pulley with flanges on both sides

Flanges on alternate side

Both pulleys with flanges on both sides

### MAXIMUM TIMING BELT WIDTH

The maximum timing belt width should not be larger than the diameter of the smallest timing belt pulley present in the drive.

### TENSION IDLERS

Idlers are toothed or flat faced pulleys that do not transmit power within a drive system. Because they create additional bending stresses within the belt, they should be used according to the following guidelines:

- Diameter of the idlers  $\geq$  the smallest permitted pulley according to the profile
- Width of the idlers  $\geq$  the timing belt pulleys present in the drive
- Always arrange idlers in the empty span
- Inside idlers:  $\leq 40$  teeth always use timing belt pulley,  $> 40$  teeth flat faced pulley possible
- As outside idlers, flat faced pulleys are to be used in general, as they run on the top surface of the belt
- Flat faced pulleys must not be of spherical shape
- The idlers must be attached in such a way that as many teeth as possible are meshed
- The arc of contact at the idler must be kept as low as possible
- Minimum span width  $\geq 2 \cdot$  belt width

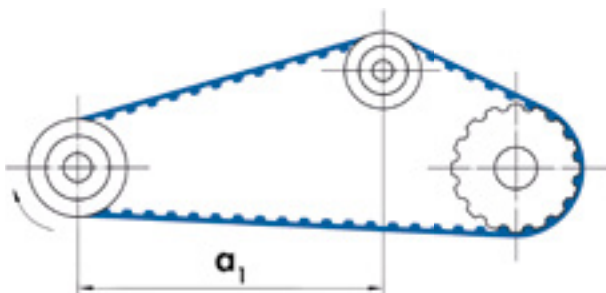

Figure 5.1.1: Arrangement of the inside tension idler

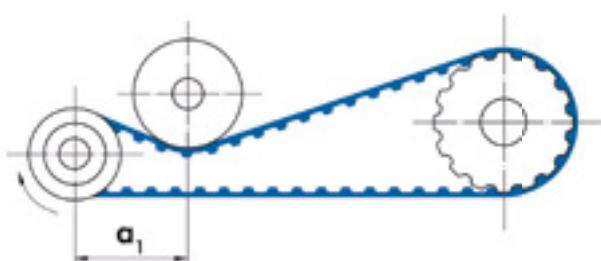

Figure 5.1.2: Arrangement of the outside tension idler



# 5 DESIGN HINTS

## 5.2 INSTALLATION AND MAINTENANCE



### SAFETY INFORMATION

Geometrically correct designing and power rating of drives with Optibelt timing belts ensures high operating reliability and an optimum lifetime. Practice has shown that premature failure can very often be traced to faulty installation or maintenance.

To prevent this, we recommend that you observe the following instructions:



- **TIMING BELT PULLEYS**

The teeth must be manufactured according to standard and also be clean.

- **ALIGNMENT**

Shafts and pulleys should be correctly aligned prior to belt installation.

Maximum deviations of shaft parallelism:

Belt width	Angular misalignment
≤ 25	± 1°
> 25 ≤ 50	± 0.5°
> 50 ≤ 100	± 0.25°
> 100 ≤	± 0.15°

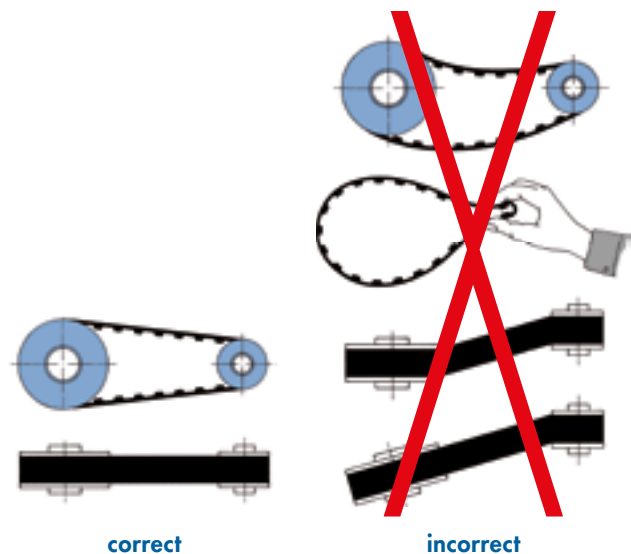

- **TIMING BELT SETS**

Timing belts which run in pairs or groups on one drive must always be ordered as a set. This guarantees that all belts originate from the same batch and are identical in length.

- **INSTALLATION**

Prior to installation, the drive centre distance must be reduced to enable the timing belt to be fitted easily.

If this is not possible, the timing belt must be installed together with one or both timing belt pulleys. Forcing belts over the pulley flanges must be avoided as the damage this causes to the high-quality low-stretch tension members is often not visible. If taper bushes are used, the studs used should be checked after an operating time of 0.5 to 1 hour with the aid of a torque spanner.

- **TENSION**

The tension must correspond to the guidelines in Chapter 3.6. Further inspections after installation are not necessary.

- **TENSION IDLERS**

Tension idlers are to be avoided. If this is not possible, refer to the recommendations in Subchapter 5.1 of this manual.

- **MAINTENANCE**

Optibelt timing belts are maintenance-free if used under normal ambient conditions. If there is clearly visible wear on belts and/or pulleys, they should be replaced; see instructions in Subchapters 5.3 and 6.2.

# 5 DESIGN HINTS

## 5.3 PROBLEMS – CAUSES – REMEDIES



Problem	Cause	Remedy
<b>Heavy wear on the loaded tooth faces of the belt</b>	Belt undertensioned Incorrect pulley profile Pitch error	Correct the tension Check profile and replace, if necessary Use wider belts with higher transmission power
<b>Excessive wear at base of tooth on belt</b>	Excessive belt tension Drive under-dimensioned Faulty timing belt pulleys	Reduce tension Enlarge timing belts or pulleys Replace timing belt pulleys
<b>Unusual wear on belt edges</b>	Improper drive centre parallelism Faulty flanges Change of drive centre distance	Re-align the shafts Replace the flanges Reinforce bearing or housing
<b>Belt teeth shearing off</b>	Overloading  Too few teeth in mesh  Ambient temperature above 80°C	Increase diameter of small pulley or select wider belt Use wider belts or larger pulleys For ambient temperature above 80°C re-design with optibelt OMEGA HP EPDM -40°C / +140°C
<b>Excessive lateral belt movement</b>	Improper drive centre parallelism Timing belt pulleys are not aligned Impact loading with too high belt tension	Re-align the shafts Align the pulleys Reduce belt tension
<b>Detachment of flanges</b>	Timing belt pulleys not in line Very high lateral pressure of the timing belt Incorrect flange installation	Re-align the timing belt pulleys Re-align the shafts  Install flanges correctly
<b>Apparent belt stretch</b>	Incorrect storage	Correct the belt tension, reinforce and secure bearing support
<b>Excessive operating noise</b>	Incorrect shaft alignment Belt tension too high Pulley diameter too small Overloading of timing belt  Belt width too wide with high speed	Re-align the shafts Reduce the tension Increase pulley diameter Increase belt width or tooth meshing Reduce belt width by selecting larger belt types
<b>Abnormal wear of timing belt pulleys</b>	Unsuitable material Incorrect tooth meshing Insufficient surface hardness	Use stronger material Replace timing belt pulleys Use harder material or harden surface
<b>Cracks on belt top surface</b>	Ambient temperatures below -30°C	Re-design with optibelt OMEGA HP EPDM -40°C / +140°C Provide heating for drive unit
<b>Softening of the belt top surface</b>	Influence of incompatible media	Shield from the media or use a suitable belt quality

# 6 TOOTHED PULLEYS

## 6.1 MINIMUM PULLEY DIAMETER AND DESIGNS



Do not use less than the recommended minimum number of teeth for pulleys, see Table 6.1.1. A pulley diameter that is smaller than the minimum pulley diameter may lead to a reduced operational reliability and an unsatisfactory operating time.

**Table 6.1.1: Minimum number of teeth and minimum diameter**

Profile	Minimum number of teeth	Minimum diameter [mm]
<b>8MDC</b>	22	56.02
<b>14MDC</b>	28	124.78

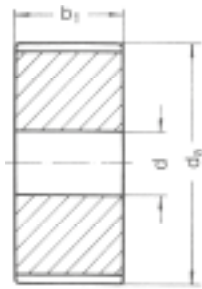

**OB type**

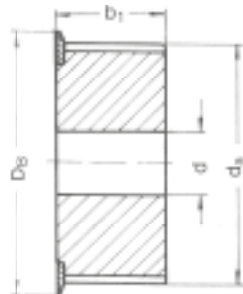

**EB type**

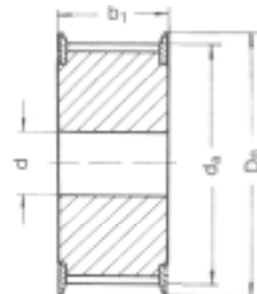

**ZB type**

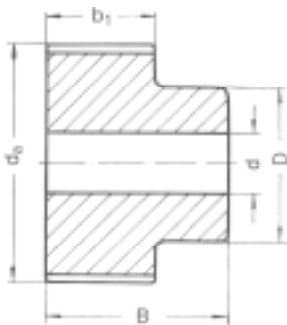

**OBN type**

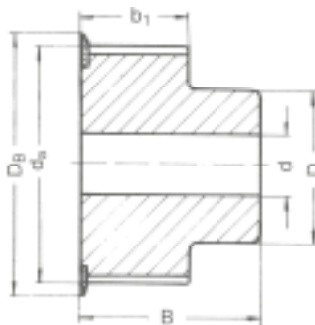

**EBN type**

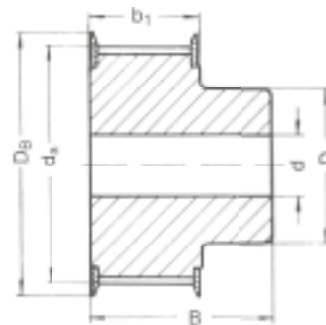

**ZBN type**

### MATERIALS

Steel, grey cast iron, aluminium;  
further materials on request  
For speeds > 30 m/s, do not use cast pulleys  
beyond this speed!

### BORES

All timing belt pulleys are pilot bored.  
On request they can be finish bored according to DIN H7.

### EXPLANATION OF THE ABBREVIATIONS

- OB without flanges
- EB one flange
- ZB two flanges
- OBN without flanges, with hub
- EBN one flange, with hub
- ZBN two flanges, with hub

# 6 TOOTHED PULLEYS

## 6.2 DIMENSIONS AND TOLERANCES



### PERMISSIBLE DEVIATION OF THE TOOTH SPACINGS

The permissible deviations in the tooth spacing between two consecutive teeth, and of the sum of deviations within a 90° arc, are indicated in the following table. These tolerances represent the spacing between the corresponding points on the right and left surfaces of consecutive teeth.

**Table 6.2.1: Permissible deviation of the tooth spacings**

Outside diameter $d_a$ [mm]	Permissible deviation of the tooth spacing [mm]	
	between two consecutive teeth	Sum within a 90° arc
> 50 ≤ 100	0.03	0.10
> 100 ≤ 175	0.03	0.13
> 175 ≤ 300	0.03	0.15
> 300 ≤ 500	0.03	0.18
> 500	0.03	0.20

**Table 6.2.2: Permissible deviation of the outside diameter**

Outside diameter $d_a$ [mm]	Permissible deviation [mm]
> 50 ≤ 100	+ 0.10 0
> 100 ≤ 175	+ 0.13 0
> 175 ≤ 300	+ 0.15 0
> 300 ≤ 500	+ 0.18 0
> 500	+ 0.20 0

The **optibelt DELTA CHAIN Carbon** high performance timing belts feature outstanding longitudinal stiffness due to the tension cord made of carbon fibres. Especially for drives with short drive centre distances or span lengths, and/or large belt widths, a reduction may be required in the permissible deviation specified for the outside diameter and the running tolerances. Tension force fluctuations and additional loads on bearings, shafts and the belt can be minimised in this way.

**Table 6.2.3: Pulley width**

Profile	Pulley width designation	For belt width [mm]	Smallest pulley width	
			with flanges $b_f^*$ [mm]	without flanges $b$ [mm]
8MDC	12	12	14	18
	21	21	23	27
	36	36	38	42
	62	62	65	69
14MDC	20	20	23	27
	37	37	40	46
	68	68	71	77
	90	90	95	101
	125	125	130	136

\* $b_f$  = pulley width between the flanges

### NOTE

The minimum width  $b$  for pulleys without flanges can be reduced, if the straight running of the drive can be adjusted. However, this must not be below the minimum width indicated for pulleys with flanges  $b_f$ .

**Table 6.2.4: Side wobble tolerance**

Outside diameter $d_a$ [mm]	Maximum total variation [mm]
≤ 100	0.10
> 100 ≤ 250	0.01 mm per 10 mm outside diameter
> 250	0.25 mm + 0.0005 mm per mm outside diameter above 250.00 mm

**Table 6.2.5: Run-out tolerance**

Outside diameter $d_a$ [mm]	Maximum total variation [mm]
≤ 200	0.10
> 200	0.0005 mm per 10 mm outside diameter, however not larger than the outside diameter tolerance

# 6 TOOTHED PULLEYS

## 6.2 DIMENSIONS AND TOLERANCES



**Table 6.2.6: Static balancing**

Steel pulleys machined on all sides must not be balanced if the circumferential speed is less than 30 m/s. Grey cast iron pulleys for medium speeds should be statically balanced as follows:

Profile	Number of teeth	Static balancing [N]
<b>8MDC</b>	≤ 130	0.08
	> 130	0.16
<b>14MDC</b>	≤ 72	0.08
	> 72	0.16

Timing belt pulleys that are used for a circumferential speed of more than 30m/s must be dynamically balanced up to  $1.8 \cdot 10^{-5}$  Nm.

### PARALLELISM

The teeth should be parallel to the centre of the bore with a maximum deviation of 0.001 mm per millimetre of width.

### CONICITY

The conicity must not be higher than 0.001 mm per millimetre of head width and must not exceed the permissible outside diameter tolerance.

# 6 TOOTHED PULLEYS

## 6.3 TAPER BUSH RANGE



### optibelt TB taper bushes

Taper bushes with metric bores and keyways to DIN 6885 part 1																
Taper bush											Material: EN-GJL-200 – DIN EN 1561					
	1008	1108	1210	1215	1310	1610	1615	2012	2517	3020	3030	3525	3535	4040	4545	5050
Bore diameter $d_2$ [mm]	10	10	11	11	14	14	14	14	14	25	35	35	35	40	55	70
	11	11	12	12	16	16	16	16	16	28	38	38	38	42	60	75
	12	12	14	14	18	18	18	18	18	30	40	40	40	45	65	80
	14	14	16	16	19	19	19	19	19	32	42	42	42	48	70	85
	15	15	18	18	20	20	20	20	20	35	45	45	45	50	75	90
	16	16	19	19	22	22	22	22	24	38	48	48	48	55	80	95
	18	18	20	20	24	24	24	24	25	40	50	50	50	60	85	100
	19	19	22	22	25	25	25	25	28	42	55	55	55	65	90	105
	20	20	24	24	28	28	28	28	30	45	60	60	60	70	95	110
	22	22	25	25	30	30	30	30	32	48	65	65	65	75	100	115
	24 ▲	24	28	28	32	32	32	32	35	50	70	70	70	80	105	120
	25 ▲	25	30	30	35	35	35	35	38	55	75	75	75	85	110	125
		28 ▲	32	32		38	38	38	40	60		80	80	90		
						40	40	40	42	65		85	85	95		
						42 ▲	42 ▲	42	45	70		90	90	100		
								45	48	75						
								48	50							
								50	55							
								60	60							
Hexagonal socket screws [in]	$1/4 \times 1/2$	$1/4 \times 1/2$	$3/8 \times 5/8$	$3/8 \times 5/8$	$3/8 \times 5/8$	$3/8 \times 5/8$	$3/8 \times 5/8$	$7/16 \times 7/8$	$1/2 \times 1$	$5/8 \times 1/4$	$5/8 \times 1/4$	$1/2 \times 1/2$	$1/2 \times 1/2$	$5/8 \times 13/4$	$3/4 \times 2$	$7/8 \times 2/4$
Torque [Nm]	5.7	5.7	20	20	20	20	20	31	49	92	92	115	115	172	195	275
Bush length [mm]	22.3	22.3	25.4	38.1	25.4	25.4	38.1	31.8	44.5	50.8	76.2	63.5	88.9	101.6	114.3	127.0
Weight at $d_2$ min [kg]	0.12	0.16	0.28	0.39	0.32	0.41	0.60	0.75	1.06	2.50	3.75	3.90	5.13	7.68	12.70	15.17

Over 3525: Cap head screw with hexagonal socket ▲ This bore has shallow keyways.

### Shallow keyways for taper bushes

Bore diameter $d_2$ [mm]	Keyway width b [mm]	Keyway depth $t_2$ [mm]	Bore diameter $d_2$ [mm]	Keyway width b [mm]	Keyway depth $t_2$ [mm]
24	8	2.0	28	8	2.0
25	8	1.3	42	12	2.2

Taper bushes with inch bores and keyway to British Standard BS 46 part 1																
Taper bush											Material: EN-GJL-200 – DIN EN 1561					
	1008	1108	1210	1215	1310	1610	1615	2012	2517	3020	3030	3525	3535	4040	4545	5050
Bore diameter $d_2$ [in]	$3/8^*$	$3/8^*$	$1/2$	$5/8^*$	$1/2^*$	$1/2$	$1/2$	$5/8^*$	$3/4$	$11/4$	$11/4$	$11/2$	$11/2$	$13/4^*$	$21/4^*$	$3^*$
	$1/2$	$1/2$	$5/8$	$3/4$	$5/8^*$	$5/8$	$5/8$	$3/4$	$7/8$	$13/8$	$13/8$	$15/8$	$15/8$	$17/8^*$	$23/8^*$	$31/4^*$
	$5/8$	$5/8$	$3/4$	$7/8$	$3/4^*$	$3/4$	$3/4$	$7/8$	1	$11/2$	$11/2$	$13/4$	$13/4$	2*	$21/2^*$	$31/2^*$
	$3/4$	$3/4$	$7/8$	1	$7/8^*$	$7/8$	$7/8^*$	1	$11/8$	$15/8$	$15/8$	$17/8$	$17/8$	$21/8^*$	$23/4^*$	$33/4^*$
	$7/8$	$7/8$	1	$11/8$	1*	1	1	$11/8$	$11/4$	$13/4^*$	$13/4^*$	2	2	$21/4^*$	$27/8^*$	4*
	1 ▲	1	$11/8$	$11/4$	$11/8$	$11/8$	$11/8$	$11/4$	$13/8$	$17/8$	$17/8$	$21/8$	$21/8$	$23/8^*$	3*	$41/4^*$
		$11/8 \Delta^*$	$11/4$		$11/4$	$11/4$	$11/4$	$13/8$	$11/2$	2	2	$21/4$	$21/4$	$21/2^*$	$31/4^*$	$41/2^*$
					$13/8$	$13/8$	$13/8$	$11/2$	$15/8$	$21/8^*$	$21/8^*$	$23/8$	$23/8$	$25/8^*$	$33/8^*$	$43/4^*$
						$11/2$	$11/2$	$15/8$	$13/4$	$21/4$	$21/4$	$21/2$	$21/2$	$23/4^*$	$31/2^*$	$5 \Delta^*$
						$15/8$	$15/8 \Delta^*$	$13/4$	$17/8$	$23/8$	$23/8$	$25/8$	$25/8$	$27/8^*$	$33/4^*$	
								$17/8$	2	$21/2$	$21/2$	$23/4$	$23/4$	3*	4*	
								2	$21/8$	$25/8$	$25/8^*$	$27/8$	$27/8$	$31/8^*$	$41/4 \Delta^*$	
									$21/4$	$23/4$	$23/4^*$	3	3	$31/4^*$	$41/2 \Delta^*$	
									$23/8$	$27/8$	$27/8$	$31/8$	$31/8$	$33/8^*$		
									$21/2$	3	3	$31/4$	$31/4$	$31/2^*$		
												$33/8$	$33/8$	$33/4 \Delta^*$		
												$31/2 \Delta$	$31/2 \Delta$	$4 \Delta^*$		
Hexagon socket screws [in]	$1/4 \times 1/2$	$1/4 \times 1/2$	$3/8 \times 5/8$	$3/8 \times 5/8$	$3/8 \times 5/8$	$3/8 \times 5/8$	$3/8 \times 5/8$	$7/16 \times 7/8$	$1/2 \times 1$	$5/8 \times 1/4$	$5/8 \times 1/4$	$1/2 \times 1/2$	$1/2 \times 1/2$	$5/8 \times 13/4$	$3/4 \times 2$	$7/8 \times 2/4$
Torque [Nm]	5.7	5.7	20	20	20	20	20	31	49	92	92	115	115	172	195	275
Bush length [mm]	22.3	22.3	25.4	38.1	25.4	25.4	38.1	31.8	44.5	50.8	76.2	63.5	88.9	101.6	114.3	127.0
Weight at $d_2$ min [kg]	0.12	0.16	0.28	0.39	0.32	0.41	0.60	0.75	1.06	2.50	3.75	3.90	5.13	7.68	12.70	15.17

Over 3525: Cap head screw with hexagonal socket \* Non-stock items ▲ This bore has a shallow keyway.

# 6 TOOTHED PULLEYS

## 6.4 TOOTHED PULLEY RANGE



optibelt **ZRS DC** toothed pulleys profile 8MDC for optibelt **TB** taper bushes

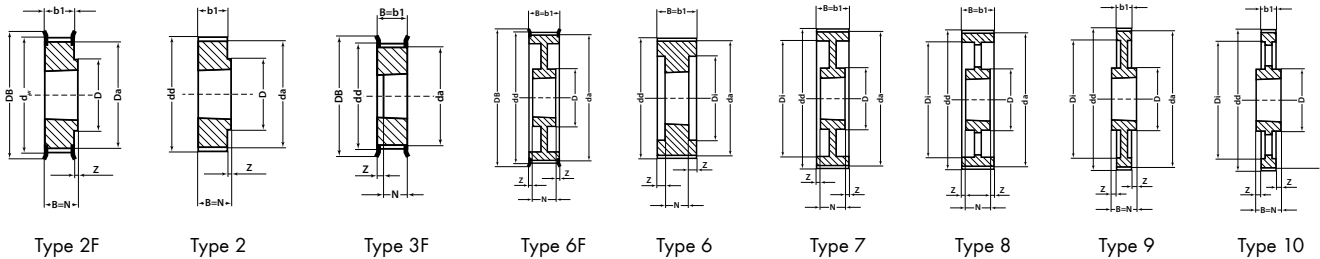

Designation	Number of teeth	De-sign	Material	$d_w$ [mm]	$d_a$ [mm]	$D_B$ [mm]	$b_1$ [mm]	$B$ [mm]	$N$ [mm]	$D$ [mm]	$D_i$ [mm]	$N$ [mm]	Taper bush	Weight of bush approx. [kg]
<b>8MDC – for belt width 12</b>														
8MDC 12 TB 25	25	2F	ST	63.66	62.06	70.0	20.0	22.0	22.0	49	–	–	1108	0.30
8MDC 12 TB 28	28	2F	ST	71.30	69.70	75.0	20.0	22.0	22.0	59	–	–	1108	0.40
8MDC 12 TB 30	30	2F	ST	76.39	74.79	82.5	20.0	25.0	25.0	60	–	–	1210	0.40
8MDC 12 TB 32	32	2F	ST	81.49	79.89	86.0	20.0	25.0	25.0	66	–	–	1610	0.40
8MDC 12 TB 34	34	2F	ST	86.58	84.98	91.0	20.0	25.0	25.0	69	–	–	1610	0.50
8MDC 12 TB 36	36	2F	ST	91.67	90.07	97.0	20.0	25.0	25.0	76	–	–	1610	0.60
8MDC 12 TB 38	38	2F	ST	96.77	95.17	102.0	20.0	25.0	25.0	78	–	–	1610	0.70
8MDC 12 TB 40	40	2F	ST	101.86	100.26	106.0	20.0	25.0	25.0	85	–	–	1610	0.90
8MDC 12 TB 45	45	2F	ST	114.59	112.99	120.0	20.0	32.0	32.0	92	–	–	2012	1.10
8MDC 12 TB 48	48	2F	ST	122.23	120.63	128.0	20.0	32.0	32.0	103	–	–	2012	1.50
8MDC 12 TB 50	50	2F	ST	127.32	125.72	135.0	20.0	32.0	32.0	104	–	–	2012	1.60
8MDC 12 TB 56	56	2F	ST	142.60	141.00	150.0	20.0	32.0	32.0	104	–	–	2012	2.10
8MDC 12 TB 60	60	2F	ST	152.79	151.19	158.0	20.0	32.0	32.0	111	–	–	2012	2.40
8MDC 12 TB 64	64	2F	ST	162.97	161.37	168.0	20.0	32.0	32.0	111	–	–	2012	2.70
8MDC 12 TB 75	75	2	GG	190.99	189.39	–	20.0	32.0	32.0	111	–	–	2012	4.60
8MDC 12 TB 80	80	2	GG	203.72	202.12	–	20.0	32.0	32.0	111	–	–	2012	5.10
8MDC 12 TB 90	90	2	GG	229.18	227.58	–	20.0	–	–	111	–	–	2012	6.40
<b>8MDC – for belt width 21</b>														
8MDC 21 TB 25	25	3F	ST	63.66	62.06	70.0	30.0	30.0	22.0	–	–	8.0	1108	0.40
8MDC 21 TB 28	28	3F	ST	71.30	69.70	75.0	30.0	30.0	25.0	–	–	5.0	1210	0.40
8MDC 21 TB 30	30	3F	ST	76.39	74.79	82.5	30.0	30.0	25.0	–	–	5.0	1210	0.60
8MDC 21 TB 32	32	3F	ST	81.49	79.89	86.0	30.0	30.0	25.0	–	–	5.0	1610	0.50
8MDC 21 TB 34	34	3F	ST	86.58	84.98	91.0	30.0	30.0	25.0	–	–	5.0	1610	0.60
8MDC 21 TB 36	36	3F	ST	91.67	90.07	97.0	30.0	30.0	25.0	–	–	5.0	1610	0.70
8MDC 21 TB 38	38	3F	ST	96.77	95.17	102.0	30.0	30.0	25.0	–	–	5.0	1610	1.00
8MDC 21 TB 40	40	3F	ST	101.86	100.26	106.0	30.0	30.0	25.0	–	–	5.0	1610	1.10
8MDC 21 TB 45	45	2F	ST	114.59	112.99	120.0	30.0	32.0	32.0	92	–	–	2012	1.30
8MDC 21 TB 48	48	2F	ST	122.23	120.63	128.0	30.0	32.0	32.0	103	–	–	2012	1.60
8MDC 21 TB 50	50	2F	ST	127.32	125.72	135.0	30.0	32.0	32.0	104	–	–	2012	1.90
8MDC 21 TB 56	56	2F	ST	142.60	141.00	150.0	30.0	32.0	32.0	111	–	–	2012	2.40
8MDC 21 TB 60	60	2F	ST	152.79	151.19	158.0	30.0	45.0	45.0	124	–	–	2517	3.20
8MDC 21 TB 64	64	2F	ST	162.97	161.37	168.0	30.0	45.0	45.0	124	–	–	2517	3.80
8MDC 21 TB 75	75	2	GG	190.99	189.39	–	30.0	45.0	45.0	124	–	–	2517	6.80
8MDC 21 TB 80	80	2	GG	203.72	202.12	–	30.0	45.0	45.0	124	–	–	2517	7.60

# 6 TOOTHED PULLEYS

## 6.4 TOOTHED PULLEY RANGE



optibelt **ZRS DC** toothed pulleys profile 8MDC for optibelt **TB** taper bushes

Designation	Number of teeth	Design	Material	d <sub>w</sub> [mm]	d <sub>a</sub> [mm]	D <sub>B</sub> [mm]	b <sub>1</sub> [mm]	B [mm]	N [mm]	D [mm]	D <sub>i</sub> [mm]	N [mm]	Taper bush	Weight of bush approx. [kg]
8MDC 21 TB 90	90	9	GG	229.18	227.58	–	30.0	45.0	45.0	124	198	7.5	2517	8.60
8MDC 21 TB 112	112	9	GG	285.21	283.61	–	30.0	45.0	45.0	124	253	7.5	2517	12.50
8MDC 21 TB 140	140	10	GG	356.51	354.91	–	30.0	51.0	51.0	150	324	10.5	3020	12.80
<b>8MDC – for belt width 36</b>														
8MDC 36 TB 28	28	3F	ST	71.30	69.70	75.0	45.0	45.0	25.0	–	–	20.0	1210	0.70
8MDC 36 TB 30	30	3F	ST	76.39	74.79	82.5	45.0	45.0	25.0	–	–	20.0	1610	0.60
8MDC 36 TB 32	32	3F	ST	81.49	79.89	86.0	45.0	45.0	25.0	–	–	20.0	1610	0.80
8MDC 36 TB 34	34	3F	ST	86.58	84.98	91.0	45.0	45.0	25.0	–	–	20.0	1610	1.00
8MDC 36 TB 36	36	3F	ST	91.67	90.07	97.0	45.0	45.0	25.0	–	–	20.0	1610	1.20
8MDC 36 TB 38	38	3F	ST	96.77	95.17	102.0	45.0	45.0	25.0	–	–	20.0	1610	1.40
8MDC 36 TB 40	40	3F	ST	101.86	100.26	106.0	45.0	45.0	32.0	–	–	13.0	2012	1.40
8MDC 36 TB 45	45	3F	ST	114.59	112.99	120.0	45.0	45.0	32.0	–	–	13.0	2012	1.90
8MDC 36 TB 48	48	3F	ST	122.23	120.63	128.0	45.0	45.0	32.0	–	–	13.0	2012	2.20
8MDC 36 TB 50	50	3F	ST	127.32	125.72	135.0	45.0	45.0	32.0	–	–	13.0	2012	2.70
8MDC 36 TB 56	56	3F	ST	142.60	141.00	150.0	45.0	45.0	45.0	–	–	–	2517	3.00
8MDC 36 TB 60	60	3F	ST	152.79	151.19	158.0	45.0	45.0	45.0	–	–	–	2517	3.80
8MDC 36 TB 64	64	3F	ST	162.97	161.37	168.0	45.0	45.0	45.0	–	–	–	2517	4.50
8MDC 36 TB 75	75	2	GG	190.99	189.39	–	45.0	51.0	51.0	150	–	–	3020	8.70
8MDC 36 TB 80	80	2	GG	203.72	202.12	–	45.0	51.0	51.0	150	–	–	3020	10.00
8MDC 36 TB 90	90	9	GG	229.18	227.58	–	45.0	51.0	51.0	150	197	3.0	3020	10.40
8MDC 36 TB 112	112	9	GG	285.21	283.61	–	45.0	51.0	51.0	150	253	3.0	3020	14.00
8MDC 36 TB 140	140	10	GG	356.51	354.91	–	45.0	51.0	51.0	150	324	3.0	3020	12.00
8MDC 36 TB 168	168	10	GG	427.81	426.21	–	45.0	65.0	65.0	198	396	10.0	3525	23.90
8MDC 36 TB 192	192	10	GG	488.92	487.32	–	45.0	65.0	65.0	198	457	10.0	3525	26.60
<b>8MDC – for belt width 62</b>														
8MDC 62 TB 40	40	3F	ST	101.86	100.26	106.0	72.0	72.0	32.0	–	–	40.0	2012	2.10
8MDC 62 TB 45	45	3F	ST	114.59	112.99	120.0	72.0	72.0	32.0	–	–	40.0	2012	3.30
8MDC 62 TB 48	48	3F	ST	122.23	120.63	128.0	72.0	72.0	45.0	–	–	27.0	2517	3.90
8MDC 62 TB 50	50	3F	ST	127.32	125.72	135.0	72.0	72.0	45.0	–	–	27.0	2517	4.70
8MDC 62 TB 56	56	6F	ST	142.60	141.00	150.0	72.0	45.0	45.0	–	111	13.5	2517	5.50
8MDC 62 TB 60	60	6F	ST	152.79	151.19	158.0	72.0	45.0	45.0	–	121	13.5	2517	6.40
8MDC 62 TB 64	64	6F	ST	162.97	161.37	168.0	72.0	45.0	45.0	–	131	13.5	2517	7.20
8MDC 62 TB 75	75	6	GG	190.99	189.39	–	72.0	72.0	51.0	–	159	10.5	3020	10.00
8MDC 62 TB 80	80	6	GG	203.72	202.12	–	72.0	72.0	51.0	–	172	10.5	3020	11.50
8MDC 62 TB 90	90	6	GG	229.18	227.58	–	72.0	72.0	51.0	–	197	10.5	3020	15.00
8MDC 62 TB 112	112	7	GG	285.21	283.61	–	72.0	72.0	51.0	150	253	10.5	3020	15.00
8MDC 62 TB 140	140	7	GG	356.51	354.91	–	72.0	72.0	65.0	198	324	3.5	3525	24.80
8MDC 62 TB 168	168	8	GG	427.81	426.21	–	72.0	72.0	65.0	198	396	3.5	3525	28.40
8MDC 62 TB 192	192	8	GG	488.92	487.32	–	72.0	72.0	65.0	198	457	3.5	3525	32.20

Taper bush	1008	1108	1210	1610	2012
Bore d <sub>2</sub> from... to...	10-25	10-28	11-32	14-42	14-50

GG: Grey cast iron ST: Steel  
 We reserve the right to alter specifications without notice.  
 Bore diameter d<sub>2</sub> see Subchapter 6.3.



# 6 TOOTHED PULLEYS

## 6.4 TOOTHED PULLEY RANGE



optibelt **ZRS DC** toothed pulleys profile 8MDC for cylindrical bore

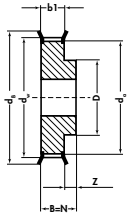

Type 1F

Designation	Number of teeth	De- sign	Material	d <sub>w</sub> [mm]	d <sub>a</sub> [mm]	D <sub>B</sub> [mm]	b <sub>1</sub> [mm]	B [mm]	S [mm]	D [mm]	Weight approx. [kg]
<b>8MDC – for belt width 12</b>											
8MDC 12 22	22	1F	ST	56.02	54.42	62.0	20.0	30.0	30.0	43	0.50
<b>8MDC – for belt width 21</b>											
8MDC 21 22	22	1F	ST	56.02	54.42	62.0	30.0	40.0	40.0	43	0.60
<b>8MDC – for belt width 36</b>											
8MDC 36 25	25	1F	ST	63.66	62.06	70.0	45.0	55.0	55.0	49	1.10
<b>8MDC – for belt width 62</b>											
8MDC 62 30	30	1F	ST	76.39	74.79	86.0	72.0	84.0	84.0	65	2.50
8MDC 62 32	32	1F	ST	81.49	79.89	90.0	72.0	84.0	84.0	69	2.80
8MDC 62 34	34	1F	ST	86.58	84.98	95.0	72.0	84.0	84.0	74	3.00
8MDC 62 36	36	1F	ST	91.67	90.07	98.0	72.0	84.0	84.0	77	3.40
8MDC 62 38	38	1F	ST	96.77	95.17	106.0	72.0	84.0	84.0	84	3.80

ST: Steel We reserve the right to alter specifications without notice.

# 6 TOOTHED PULLEYS

## 6.4 TOOTHED PULLEY RANGE



optibelt **ZRS DC** toothed pulleys profile 14MDC for optibelt **TB** taper bushes

RANGE OF  
optibelt ZRS DC TOOTHED PULLEYS  
WITH PROFILE 14MDC  
UNDER DEVELOPMENT

# 6 TOOTHED PULLEYS

## 6.4 TOOTHED PULLEY RANGE



optibelt **ZRS DC** toothed pulleys with profile 14MDC for optibelt **TB** taper bushes

RANGE OF  
optibelt ZRS DC TOOTHED PULLEYS  
WITH PROFILE 14MDC  
UNDER DEVELOPMENT

# 6 TOOTHED PULLEYS

## 6.4 TOOTHED PULLEY RANGE



optibelt **ZRS DC** toothed pulleys with profile 14MDC for cylindrical bore

RANGE OF  
optibelt ZRS DC TOOTHED PULLEYS  
WITH PROFILE 14MDC  
UNDER DEVELOPMENT

# 7. GENERAL INFORMATION

## 7.1 OVERVIEW OF STANDARDS



### Federal Republic of Germany

DIN 109 Sheet 1	– Drive Elements; Circumferential Speeds
DIN 109 Sheet 2	– Drive Elements; Centre Distances for V-Belt Drives
DIN 111	– Pulleys for Flat Transmission Belts; Dimensions, Nominal Torques
DIN 111 Sheet 2	– Pulleys for Flat Transmission Belts; Classification for Electrical Machines
DIN 2211 Sheet 1	– Grooved Pulleys for Narrow V-Belts; Dimensions, Materials
DIN 2211 Sheet 2	– Grooved Pulleys for Narrow V-Belts; Inspections of Grooves
DIN 2211 Sheet 3	– Grooved Pulleys for Narrow V-Belts; Classification for Electrical Machines
DIN 2215	– Endless V-Belts, Classical Profiles; Minimum Datum Diameter of the Pulleys, Internal and Datum Belt Length
DIN 2216	– Open-Ended V-Belts; Dimensions
DIN 2217 Sheet 1	– V-Belt Pulleys for Classical Profiles; Dimensions, Materials
DIN 2217 Sheet 2	– V-Belt Pulleys for Classical Profiles; Inspections of Grooves
DIN 2218	– Endless V-Belts, Classic Profiles for Mechanical Engineering; Calculation of Drives, Performance Data
DIN 7716	– Rubber Products; Requirements for Storage, Cleaning and Maintenance
DIN 7719 Part 1	– Endless Wide V-Belts for Industrial Speed Changers; Belts and Groove Profiles for Corresponding Pulleys
DIN 7719 Part 2	– Endless Wide V-Belts for Industrial Speed Changers; Measurement of Centre Distance Variations
DIN 7721 Part 1	– Synchronous Belt Drives, Metric Pitch; Synchronous Belts
DIN 7721 Part 2	– Synchronous Belt Drives, Metric Pitch; Tooth Space Profile of Synchronous Pulleys
DIN 7722	– Endless Hexagonal Belts for Agricultural Machines and Groove Profiles of Corresponding Pulleys
DIN 7753 Part 1	– Endless Narrow V-Belts for Mechanical Engineering; Dimensions
DIN 7753 Part 2	– Endless Narrow V-Belts for Mechanical Engineering; Drive Calculation, Performance Data
DIN 7753 Part 3	– Endless Narrow V-Belts for the Automotive Industry; Dimensions
DIN 7753 Part 4	– Endless Narrow V-Belts for the Automotive Industry; Fatigue Testing
DIN 7867	– V-Ribbed Belts and Pulleys
DIN/ISO 5290	– Grooved Pulleys for Joined Narrow V-Belts; Groove Profiles 9J; 15J; 20J; 25J
DIN 22100-7	– Articles from Synthetics for Use in Underground Mines, Paragraph 5.4 – V-Belts
DIN EN 60695-11-10	– Fire Hazard Testing

ISO 2790	– Narrow V-Belt Drives for the Automotive Industry; Dimensions
ISO 3410	– Endless Speed Changer Belts and Pulleys for Agricultural Machinery
ISO 4183	– Grooved Pulleys for Classical V-Belts and Narrow V-Belts
ISO 4184	– Classical V-Belts and Narrow V-Belts; Lengths
ISO 5256	– Synchronous Belt Drives; Belt Tooth Pitch Code Part 1 MXL; XL; L; H; XH; XXH Part 2 MXL; XXL Metric Dimensions
ISO 5287	– Narrow V-Belt Drives for the Automotive Industry; Fatigue Test
ISO 5288	– Vocabulary from Timing Belt Drives
ISO 5289	– Endless Double Profile V-Belts and Pulleys for Agricultural Machinery
ISO 5290	– Grooved Pulleys for Joined Narrow V-Belts; Profiles: 9J; 15J; 20J; 25J
ISO 5291	– Grooved Pulleys for Joined Classical V-Belts; Profiles: AJ; BJ; CJ; DJ
ISO 5292	– Industrial V-Belt Drives; Calculations of the Performance Data and Centre Distance
ISO 5295	– Timing Belts; Calculations of the Performance Data and Centre Distance – "Inch Pitch"
ISO 8370-1	– Dynamic Test to Determine Pitch Zone Location with V-Belts
ISO 8370-2	– Dynamic Test to Determine Pitch Zone Location with V-Ribbed Belts
ISO/DIS 8419	– Belt Drives; Joined Narrow V-Belts; Lengths in Effective System; 9N/J, 15N/J, 25N/J
ISO 9010	– Synchronous Belt Drives – Automotive Belts
ISO 9011	– Synchronous Belt Drives – Automotive Pulleys
ISO 9563	– Antistatic Endless Synchronous Belts; Electrical Conductibility; Characteristics and Testing Method
ISO 9980	– Belt Drives; V-Belt Pulleys, Geometric Inspection of Grooves
ISO 9981	– Belt Drives – Pulleys and V-Ribbed Belts for the Automotive Industry; PK Profile
ISO 9982	– Belt Drives; Pulleys and V-Ribbed Belts for Industrial Requirements; Geometric Data PH, PJ, PK, PL, PM
ISO 11749	– Belt Drives – V-Ribbed Belts for the Automotive Industry, Fatigue Testing
ISO 12046	– Synchronous Belt Drives – Automotive Belts – Physical Characteristics
ISO 13050	– Synchronous Belt Drives – Metric Pitch, Curvilinear Profile Systems G, H, R and S, Belts and Pulleys
ISO 17396	– Synchronous Belt Drives – Metric Pitch, Trapezoidal Profile Systems T and AT, Belts and Pulleys
ISO 19347	– Synchronous belt drives – Imperial pitch trapezoidal profile system -- Belts and pulleys

### ISO – International Organization for Standardization

ISO 22	– Widths of Flat Transmission Belts and Corresponding Pulleys
ISO 63	– Flat Belt Drives; Lengths
ISO 99	– Diameter of the Belt Pulleys for Flat Belts
ISO 100	– Bulging Height of the Belt Pulleys for Flat Belts
ISO 155	– Belt Pulleys; Limiting Values for Adjustment of Centre Distances
ISO 254	– Quality, Finish and Balance of Belt Pulleys
ISO 255	– Pulleys for Classical V-Belts and Narrow V-Belts; Geometric Testing of Grooves
ISO 1081	– Vocabulary from V-Belts, V-Ribbed Belts and Pulleys
ISO 1604	– Endless Speed Changer Belts and Pulleys for Mechanical Engineering
ISO 1813	– Electrical Conductivity of V-Belts, Kraftbands, V-Ribbed Belts, Wide V-Belts and Double Profile V-Belts
ISO 2230	– Please Consult DIN 7716

### USA

RMA/ARPM IP-20	– Classical V-Belts and Sheaves (A; B; C; D; Cross Profiles)
RMA/ARPM IP-21	– Double (Hexagonal) Belts (AA; BB; CC; DD Cross Profiles)
RMA/ARPM IP-22	– Narrow Multiple V-Belts (3V; 5V; and 8V Cross Profiles)
RMA/ARPM IP-23	– Single V-Belts (2L; 3L; 4L; and 5L Cross Profiles)
RMA/ARPM IP-24	– Synchronous Belts (MXL; XL; L; H; XH; and XXH Belt Profiles)
RMA/ARPM IP-25	– Variable Speed V-Belts (12 Cross Profiles)
RMA/ARPM IP-26	– V-Ribbed Belts (PH; PJ; PK; PL; and PM Cross Profiles)
RMA/ARPM IP-27	– Curvilinear Toothed Synchronous Belts (8M – 14M Pitches)
ASAE S 211...	– V-Belt Drives for Agricultural Machines
SAE J636b	– V-Belts and Pulleys
SAE J637	– Automotive V-Belt Drives

# 7. GENERAL INFORMATION

## 7.2 DATA SHEET FOR CALCULATION / CHECKING OF TIMING BELT DRIVES



Company: \_\_\_\_\_  
 Street address/P.O. Box number: \_\_\_\_\_  
 Town or city/Post code: \_\_\_\_\_  
 Contact person: \_\_\_\_\_  
 Department: \_\_\_\_\_ Date: \_\_\_\_\_  
 Phone: \_\_\_\_\_ Fax: \_\_\_\_\_  
 E-mail: \_\_\_\_\_

For test  New drive   
 For pilot production  Existing drive   
 For series production  Requirement \_\_\_\_ Pieces/year

Currently fitted with:

pitch length	profile	width	manufacturer

### PRIME MOVER

Type (e.g. electric motor, diesel engine 3 cylinders) \_\_\_\_\_  
 Size of the starting torque (e.g. MA = 1.8 MN) \_\_\_\_\_  
 Type of start (e.g. star delta) \_\_\_\_\_  
 Daily operating time \_\_\_\_\_ hours  
 Number of starts \_\_\_\_\_ per hour  per day   
 Change in the direction of rotation per minute  per hour   
 Power: P normal \_\_\_\_\_ kW  
 P maximum \_\_\_\_\_ kW  
 or max. torque \_\_\_\_\_ Nm at  $n_1$  \_\_\_\_\_  $\text{min}^{-1}$   
 Speed of driver pulley  $n_1$  \_\_\_\_\_  $\text{min}^{-1}$   
 Shaft layout: horizontal  vertical   
 inclined   $\alpha$  \_\_\_\_\_ °  
 Maximum allowed static shaft loading  $S_{a \max}$  \_\_\_\_\_ N  
 Pitch diameter or number of teeth on the pulley:  
 $d_{w1}$  \_\_\_\_\_ mm  $z_1$  \_\_\_\_\_ mm  
 $d_{w1 \min}$  \_\_\_\_\_ mm  $z_{1 \min}$  \_\_\_\_\_ mm  
 $d_{w1 \max}$  \_\_\_\_\_ mm  $z_{1 \max}$  \_\_\_\_\_ mm  
 Maximum pulley face width \_\_\_\_\_ mm

### DRIVEN MACHINE

Type (e.g. lathe, compressor) \_\_\_\_\_  
 Start: under load  no load   
 Type of load: steady  pulsating   
 shock   
 Required power: P normal \_\_\_\_\_ kW  
 P maximal \_\_\_\_\_ kW  
 or max. torque \_\_\_\_\_ Nm at  $n_2$  \_\_\_\_\_  $\text{min}^{-1}$   
 Driven speed  $n_2$  \_\_\_\_\_  $\text{min}^{-1}$   
 $n_{2 \min}$  \_\_\_\_\_  $\text{min}^{-1}$   
 $n_{2 \max}$  \_\_\_\_\_  $\text{min}^{-1}$   
 Maximum allowed shaft loading  $S_{a \max}$  \_\_\_\_\_ N  
 Pitch diameter or number of teeth on the pulley:  
 $d_{w2}$  \_\_\_\_\_ mm  $z_2$  \_\_\_\_\_ mm  
 $d_{w2 \min}$  \_\_\_\_\_ mm  $z_{2 \min}$  \_\_\_\_\_ mm  
 $d_{w2 \max}$  \_\_\_\_\_ mm  $z_{2 \max}$  \_\_\_\_\_ mm  
 Maximum pulley face width \_\_\_\_\_ mm

Speed ratio  $i$  \_\_\_\_\_  
 $i_{\min}$  \_\_\_\_\_  $i_{\max}$  \_\_\_\_\_  
 Drive centre distance  $a$  \_\_\_\_\_ mm  
 $a_{\min}$  \_\_\_\_\_ mm  $a_{\max}$  \_\_\_\_\_ mm  
 Tension/guide idler pulley: inside idler   
 outside idler   
 in drive slack side   
 in drive tigth side   
 $d_w$  \_\_\_\_\_ mm pulley   
 moveable  (e.g. spring loaded) \_\_\_\_\_  
 $d_a$  \_\_\_\_\_ mm flat pulley   
 fixed   
**Operating conditions** Ambient temperature \_\_\_\_\_ °C/F minimum  
 \_\_\_\_\_ °C/F max.  
 Influence of oil  (e.g. oil mist, drops) \_\_\_\_\_  
 water  (e.g. spray water) \_\_\_\_\_  
 acid  (type, concentration, temperature) \_\_\_\_\_  
 dust  (type) \_\_\_\_\_

Special drives: e.g. for drives with inside or outside tensioning/idler pulleys, three or more multi-pulley drives or for drives with contra-rotating pulleys drawings are necessary. Please use the other side of this page for these drawings.







**Optibelt GmbH**

Corveyer Allee 15  
37671 Hörter  
GERMANY

T +49 (0) 5271-621  
F +49 (0) 5271-976200  
E [info@optibelt.com](mailto:info@optibelt.com)



[www.optibelt.com](http://www.optibelt.com)